

## Kenwood TS-2000 receiver crackling noise problem

### Ceramic filter failure – how to change the filters

The symptoms is as follows: Suddenly there are strong receiver noise like static crashes, the noise can come and go but many have reported it to appear after the radio has been on for a while. The noise is the same on all bands, and the noise is the same even without any antenna connected.

The problem is the failure of the small black ceramic filters (CF1, CF2 and CF4) on the MAIN receiver. But both MAIN and SUB receiver can have this failure. These filters are the TOKO ALFYM455E (15kHz wide) and the ALFYM455G (9kHz wide). I found equivalent filters LTM455EW (15kHz wide) and LTM455GW (9kHz wide). These have exact same electrical data, so it is safe to use them without any re-tuning of the radio. On the SUB receiver, there is 2 ceramic filters on the E (EU) version (FM-W and FM-N), the K (USA) version has only one filter (FM-W).

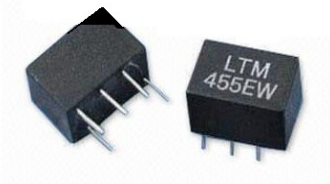

The MAIN receiver filters are located on the TX/RX board in the bottom (underside) of the radio. The board are marked right next to the filters, CF1, CF2, CF3 (Murata CFJ455K 12) and CF4. The Murata 2.7kHz ceramic filter (CF3) is a different construction and does not need to be replaced.

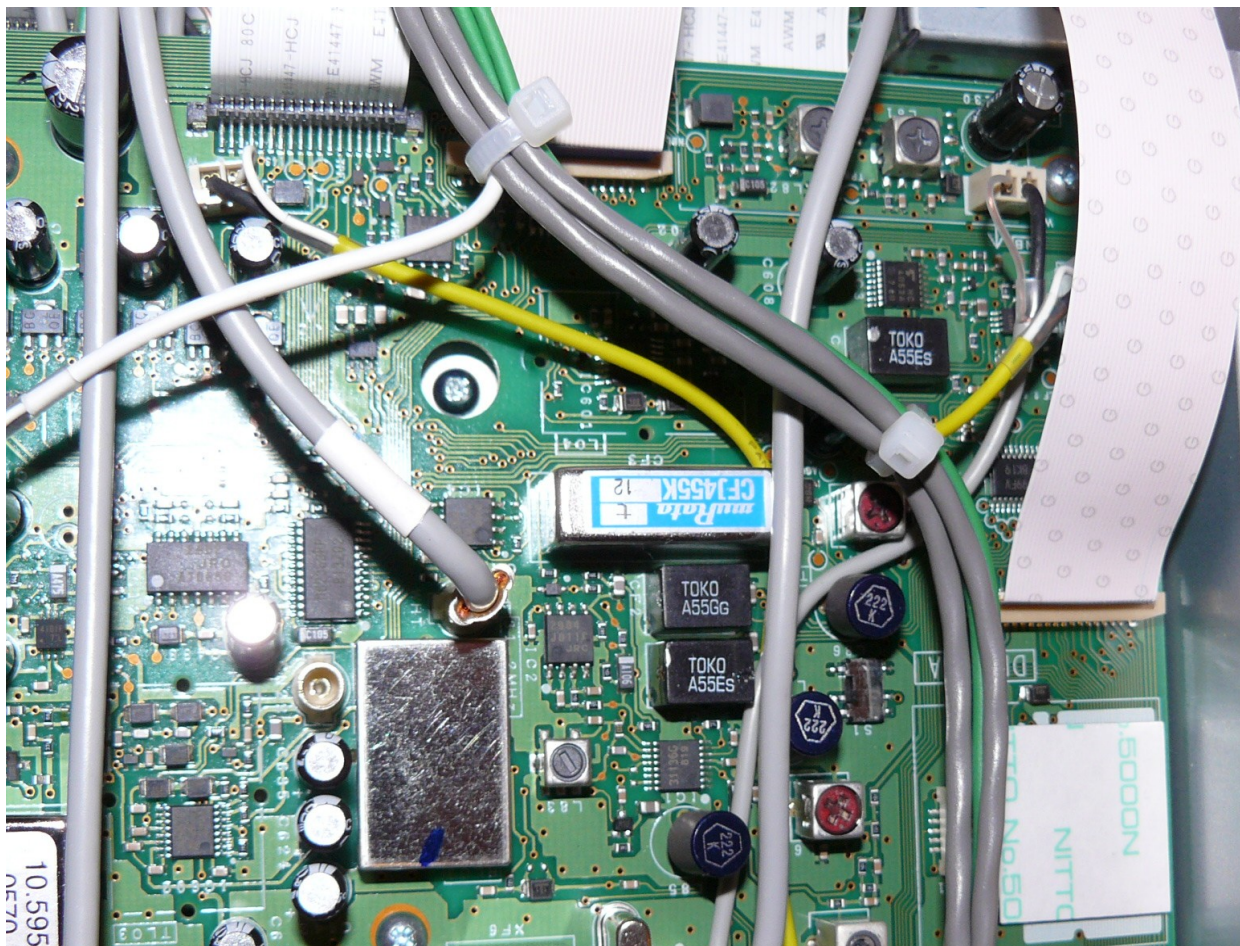

I decided to replace all filters with YIC LTM455EW and LTM455GW because the original TOKO filters have develop this problem, so I did not want to put in the same filter. These YIC filters is available at eBay for £1.20 (G.B.P) / each. Also, ECS Inc. and others make these LTM455 filters.

**Remember to use ESD protection (grounded wrist cable) when handling the board !!**  
**Be careful not to touch any of the potentiometers on the board, this may de-tune the radio !**

The procedure: Remove the bottom cover. Remove the small steel spring plate that holds the transistors at the side of the radio. Remove only one cable (mini coax) at the rear of the radio.

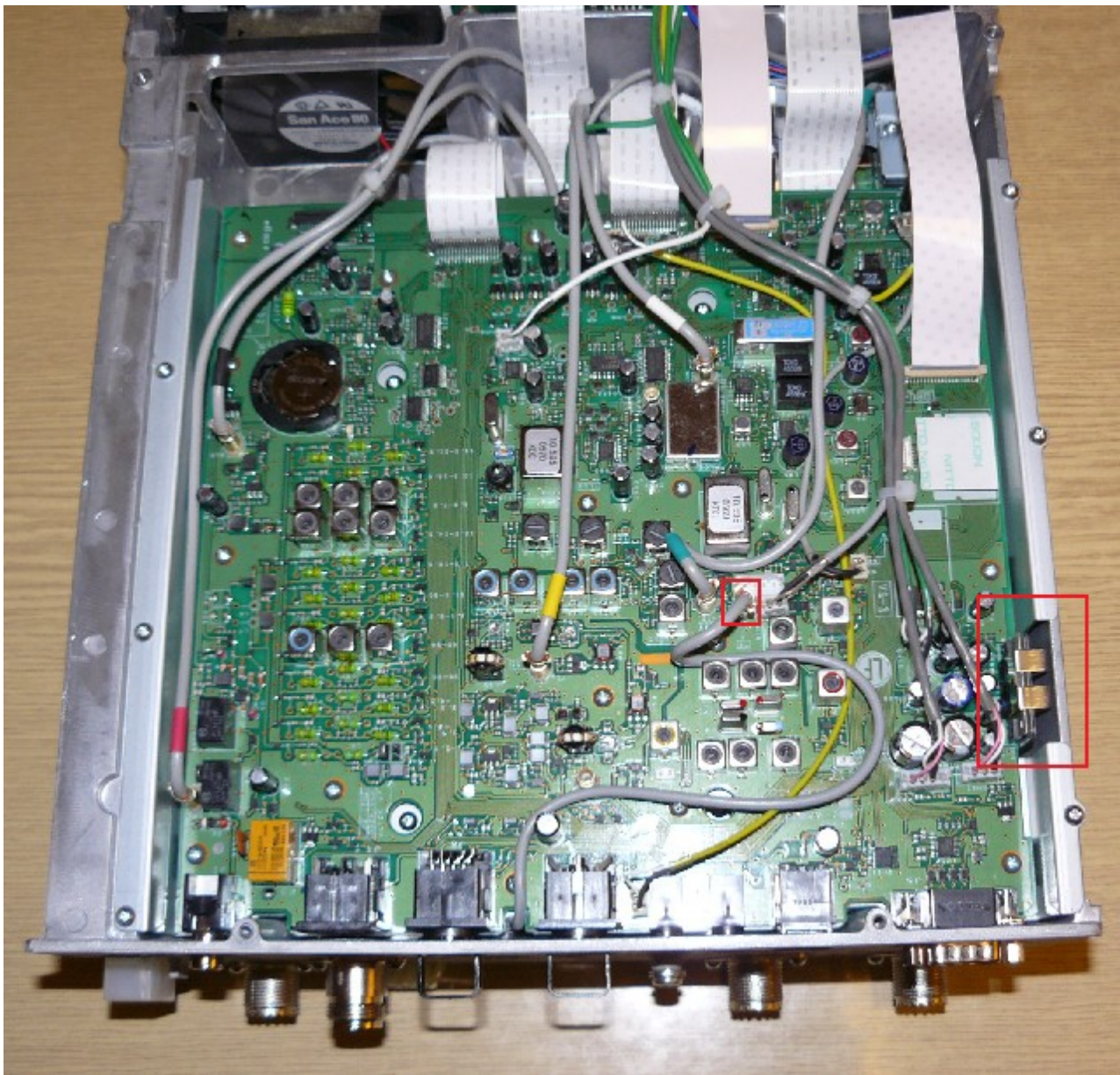

Unscrew all the small screws that holds the TX/RX board. Leave all the flat cables and other cables connected at the front end and other places on the board. Place a suitable support in front of the radio (same height as the radio) allowing the TX/RX board to be laid on this during soldering.

Just lift the board up a bit and move the board a bit towards the front to make all the rear connectors come clear of the aluminum chassis rear end, be aware of the location pin that sticks up in a hole in the board at the rear end. You must lift the board to enable this pin to come clear of the board.

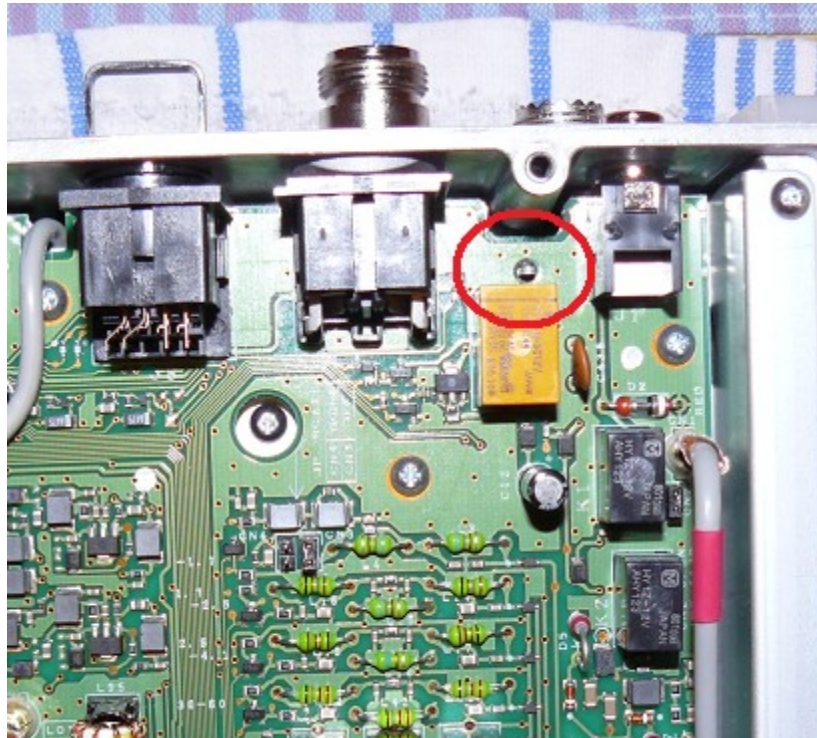

Then flip the board around and lay it with the bottom up on the support to allow soldering on the rear side of the board.

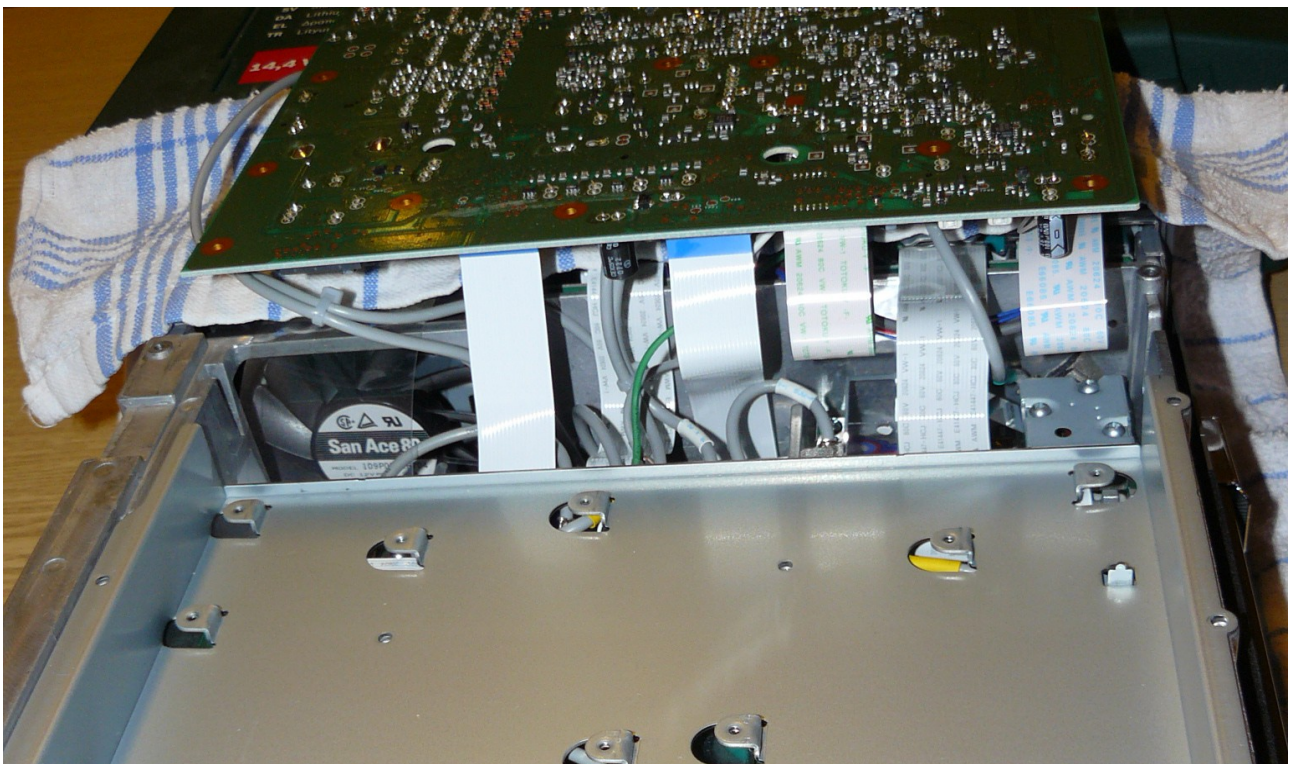

You may want to change the SUB receiver ceramic filter(s) as well. Remove the metal shield plate. Locate the Filter on the SUB receiver TX/RX board. This is quite a lot of work as you must remove several cables, then lift out the board and solder out the old filter. Then solder in the new filter(s).

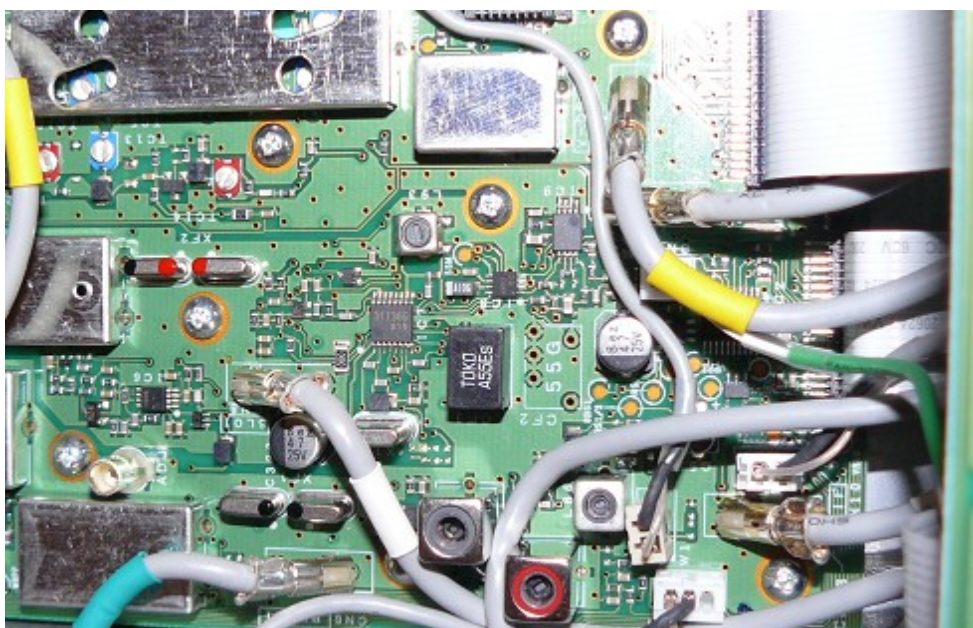

Note this K (USA) version has only the FM-W filter. Replace it with a LTM455EW (15kHz).

One possible reason for the filter failures are the possibility of too high temperature during soldering with lead-free solder. If too much heat is applied for too long during soldering, the filter may be damaged. During re-soldering I used ordinary “old fashion” solder with 60% tin, 38% lead and 2% copper.

The rear side of the Main TX/RX board do show signs of bad soldering:

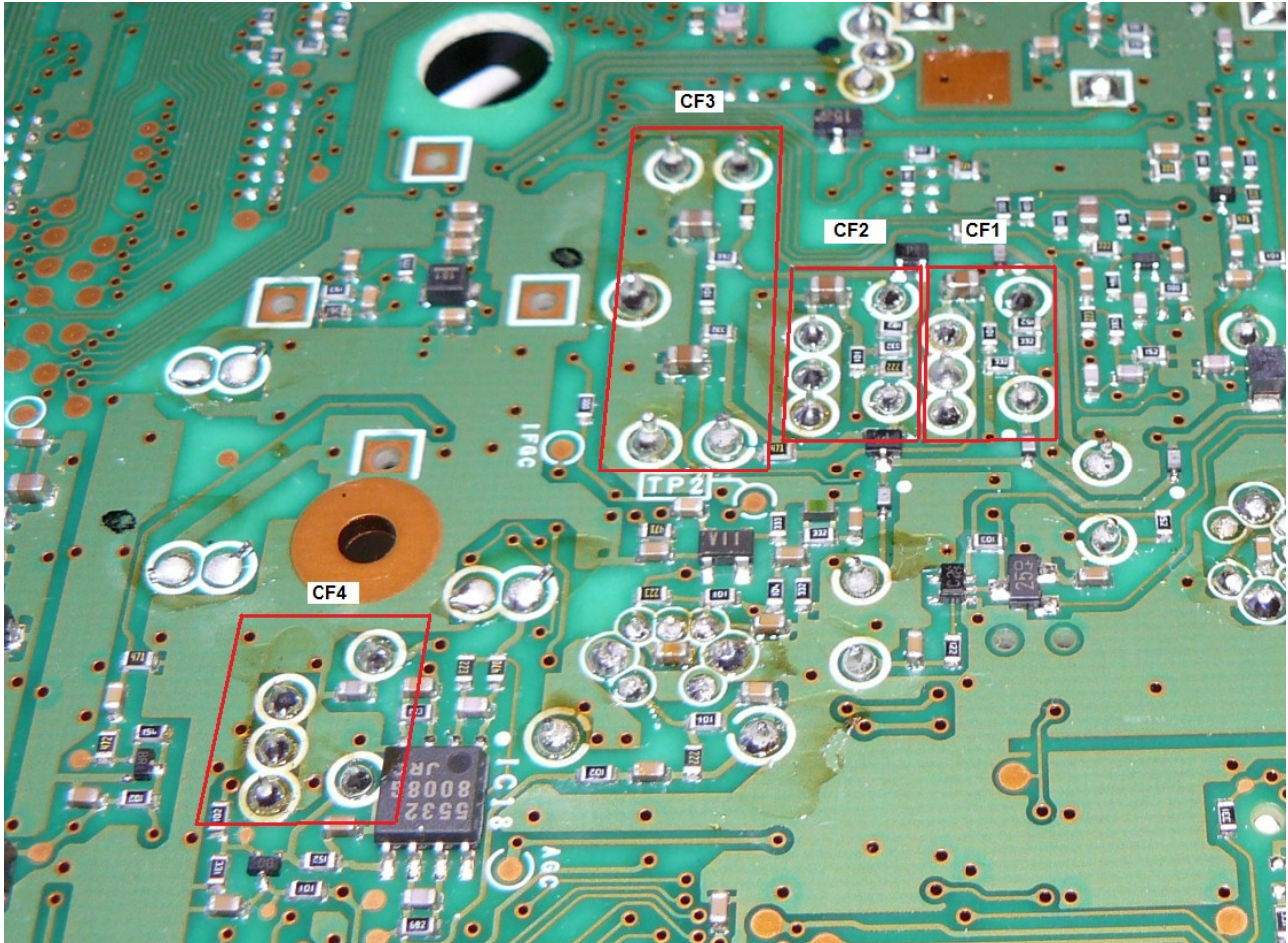

The SMD components is of course soldered using a machine, but filters and other large component/parts seems to have been soldered by hand at a later time. There are also some small tin-blobs lying on the board here and there, and on my Radio there was some kind of white powdery substance that was “splashed” out on one corner of the board.

**WARNING !** The un-soldering of these filters is very difficult ! You must use a de-soldering special tool to suck out the solder around the pins. Don't try this with simple equipment, ask a professional for help. It is better to pay a bit for this job rather than destroying the print and surrounding SMD components. Tiny SMD components are very close to the filter pins. **Be careful !**  
I Take no responsibility if you destroy your radio by doing this modification.

The circuit in the service manual show there is no DC blocking capacitor on the output of the CF4 filter. TOKO recommend a DC decoupling capacitor to be installed for safety reasons. The signal goes thru the resistor R226 (1.5k $\Omega$ ) and directly to pin B+Input on IC. Thus, there is around 1.5V DC on pin 2 on the filter. This must be avoided. So we must install a DC block capacitor on the output of CF4.

## TS-2000 Main TX-RX unit CF4 ceramic filter circuit

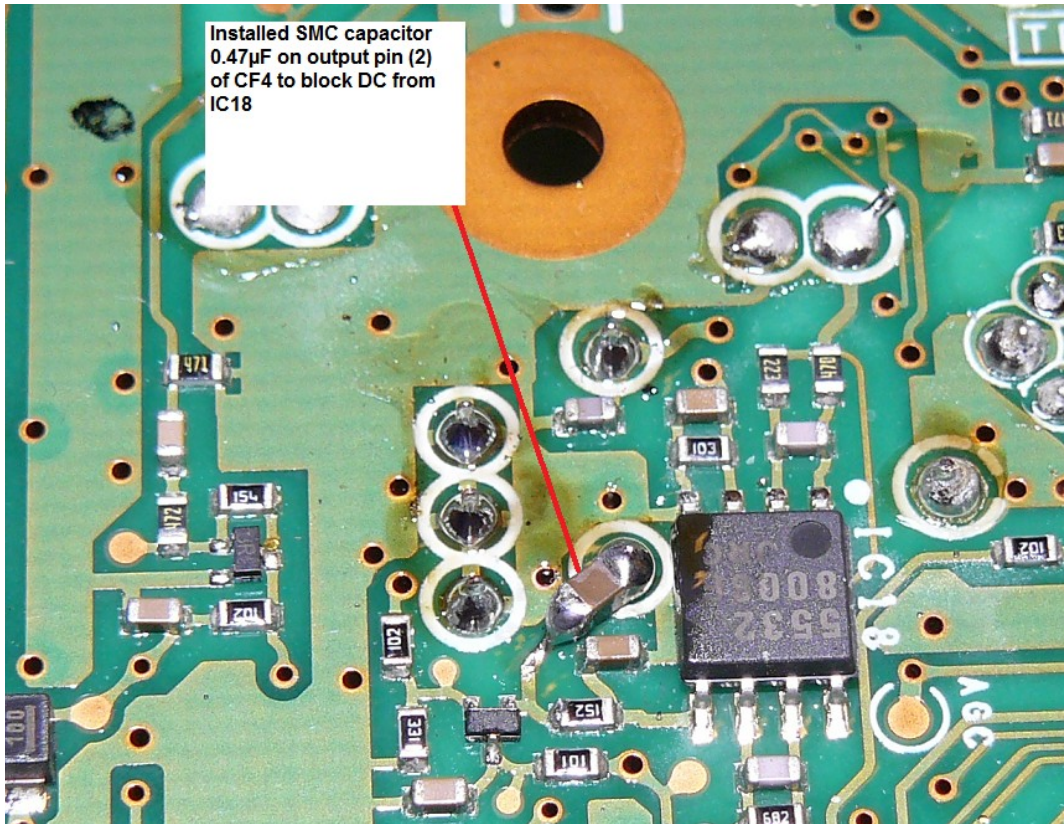
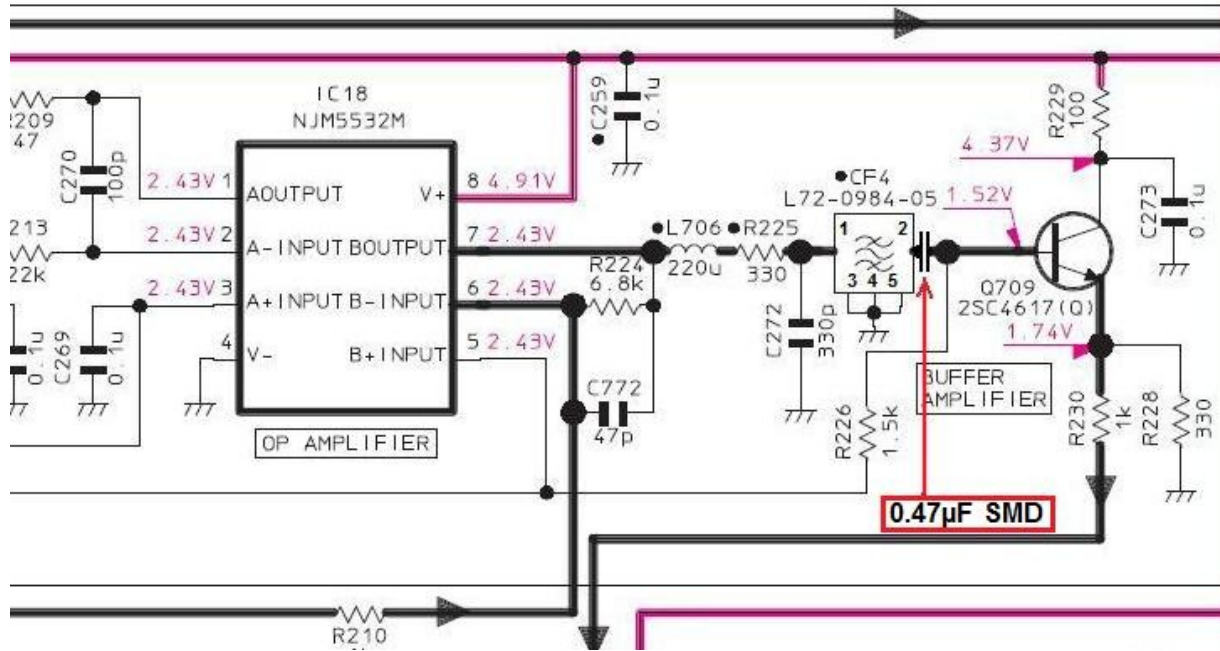

Install DC block 0.47uF 0805 X5R capacitor on the output of CF4 to prevent DC from destroying the filter. The X5R has less than 1Ω impedance at 455kHz, so no other impact than DC block will occur in the circuit. You must cut the trace and solder in the SMD capacitor, I found size 0805 to fit nicely. The trace is very small so extreme care must be taken when cutting/soldering.



The new filters installed. My TS-2000 now works great, and problem is solved !

Best regards – LA4AMA – Roar