



KENWOOD

INSTRUCTION MANUAL

144/440 MHz FM DUAL BANDER

TM-D710A (K type)

144/430 MHz FM DUAL BANDER

TM-D710A (M4 type)

TM-D710E (E type)

Version: 2.10

©Kenwood Corporation

CONTENTS

Operation	File name (TM-D710_)
OPERATING THROUGH REPEATERS REPEATER-	
OPERATING THROUGH REPEATERS.....1	01_REPEATER_E.pdf
REPEATER ACCESS.....1	
Selecting an Offset Direction.....1	
Selecting an Offset Frequency.....1	
Activating the Tone Function.....1	
Selecting a Tone Frequency2	
Automatic Repeater Offset (K and E Types Only)2	
TRANSMITTING A 1750 Hz TONE3	
REVERSE FUNCTION3	
AUTOMATIC SIMPLEX CHECKER (ASC).....3	
TONE FREQUENCY ID.....3	
MEMORY CHANNELS MEMORY CH-	
MEMORY CHANNELS1	02_MEMORY CHANNEL_E.pdf
SIMPLEX & REPEATER OR ODD-SPLIT MEMORY CHANNEL?.....1	
STORING SIMPLEX AND STANDARD REPEATER FREQUENCIES1	
Call Channel Memory (Simplex)1	
STORING ODD-SPLIT REPEATER FREQUENCIES.....2	
Call Channel Memory (Odd-Split)2	
RECALLING A MEMORY CHANNEL.....2	
Memory Recall Method2	
CLEARING A MEMORY CHANNEL.....2	
NAMING A MEMORY CHANNEL.....3	
MEMORY-TO-VFO TRANSFER.....3	
CHANNEL DISPLAY FUNCTION.....3	
PROGRAMMABLE MEMORY (PM) PM-	
APPLICATION EXAMPLES.....1	03_PM CHANNEL_E.pdf
STORING DATA IN PM CHANNELS2	
RECALLING PM CHANNELS.....2	
AUTO PM CHANNEL STORE2	
PM CHANNEL RESET2	
SCAN SCAN-	
SELECTING A SCAN RESUME METHOD1	04_SCAN_E.pdf
VFO SCAN1	
MEMORY SCAN.....2	
Locking Out a Memory Channel.....2	
GROUP SCAN.....2	
Memory Group Link.....2	
PROGRAM SCAN3	
Setting Scan Limits3	
Using Program Scan3	
MHz SCAN3	

CALL SCAN.....	3	
VISUAL SCAN	4	
Selecting the Number of Channels	4	
Using Visual Scan.....	4	
CONTINUOUS TONE CODED SQUELCH SYSTEM (CTCSS)	CTCSS-	05_CTCSS_E.pdf
USING CTCSS	1	
CTCSS FREQUENCY SCAN.....	2	
DIGITAL CODED SQUELCH (DCS).....	DCS-	06_DCS_E.pdf
USING DCS.....	1	
DCS CODE SCAN.....	1	
DUAL TONE MULTI-FREQUENCY (DTMF)	DTMF-	07_DTMF_E.pdf
MANUAL DIALING	1	
DTMF Hold.....	1	
AUTOMATIC DIALER.....	1	
Storing a DTMF Code in Memory	1	
Transmitting Stored DTMF Codes	2	
Selecting a Transmit Speed	2	
Selecting a Pause Duration.....	2	
DTMF KEY LOCK.....	2	
EchoLink®	EchoLink-	08_EchoLink_E.pdf
STORING EchoLink MEMORY.....	1	
Transmitting EchoLink Memory.....	1	
Selecting a Transmit Speed	2	
SETTING UP EchoLink Sysop MODE.....	2	
OTHER OPERATIONS	OTHER OP-	09_OTHER OPERATIONS_E.pdf
POWER ON MESSAGE	1	
DISPLAY ILLUMINATION	1	
Auto Display Brightness.....	1	
Backlight Color	1	
Display Contrast.....	1	
Positive/ Negative Reversal	1	
KEY LOCK.....	1	
Microphone Key Lock.....	1	
KEY BEEP	2	
Beep Volume.....	2	
EXTERNAL SPEAKER CONFIGURATION.....	2	
PROGRAMMABLE VFO.....	2	
CHANGING THE FREQUENCY STEP SIZE	3	
PROGRAMMABLE FUNCTION KEYS.....	3	
Transceiver Front Panel.....	3	
Microphone Keys	3	
FREQUENCY DIRECT ENTRY.....	3	
AUTOMATIC POWER OFF (APO).....	4	
SWITCHING FM/AM MODE	4	
ADVANCED INTERCEPT POINT (AIP)	4	
S-METER SQUELCH	4	
Squelch Hang-up Time	4	

SPEAKER MUTE.....	5	
Mute Hang-up Time	5	
BEAT SHIFT	5	
SELECTING AN OUTPUT POWER	5	
TIME-OUT TIMER (TOT).....	5	
MICROPHONE SENSITIVITY	5	
MASKING A BAND	6	
DISPLAY PARTITION BAR	6	
POWER ON PASSWORD	6	
PACKET OPERATION	PACKET-	10_PACKET_E.pdf
PACKET MODE.....	1	
DATA BAND	2	
COM PORT SPEED	2	
USING EXTERNAL TNC	2	
External Data Band	2	
DATA Terminal Speed	2	
PC Port Speed	2	
SQC Output Setting	2	
TNC COMMANDS LIST.....	3	
APRS®	APRS-	11_APRS_E.pdf
CONNECTING WITH A GPS RECEIVER OR WEATHER STATION	2	
ADJUSTING THE INTERNAL CLOCK	2	
Setting Date	2	
Setting Time	2	
Setting UTC Offset	2	
RECEIVING APRS DATA.....	3	
ACCESSING RECEIVED APRS DATA	4	
CURSOR CONTROL.....	4	
DISPLAY EXAMPLE.....	5	
SORT FUNCTION	6	
DISPLAY FILTER FUNCTION.....	6	
RECEIVING A MESSAGE	7	
ENTERING A MESSAGE	7	
ACCESSING RECEIVED APRS MESSAGES	8	
TRANSMITTING A MESSAGE	8	
BASIC SETTINGS	9	
My Callsign <MY CALLSIGN>	9	
Beacon Type <BEACON TYPE>	9	
SETTING INTERNAL TNC	9	
Data Band <DATA BAND>	9	
Packet Transfer Rate <DATA SPEED>	9	
DCD Sense <DCD SENSE>	9	
TX delay <TX DELAY>	9	
SETTING GPS PORT.....	10	
Baud Rate <BAUD RATE>	10	
Input Type <INPUT>	10	
Output Type <OUTPUT>	10	
SETTING WAY POINT	10	
Way Point Format <FORMAT>	10	

Way Point Name <NAME>.....	10
Way Point Output <OUTPUT>.....	10
COM PORT ON/OFF.....	10
Output <OUTPUT>.....	10
PROGRAMMING POSITION DATA.....	11
Select Position channel.....	11
Name Entry <NAME>.....	11
Latitude Entry <LATITUDE>.....	11
Longitude Entry <LONGITUDE>.....	11
SETTING BEACON INFORMATION.....	11
Speed Information <SPEED>.....	11
Altitude Information <ALTITUDE>.....	11
Position Ambiguity <POSITION AMBIGUITY>.....	11
SELECTING A POSITION COMMENT.....	11
STORING STATUS TEXT.....	11
Text <TEXT>.....	11
Text Transmit Frequency <TX RATE>.....	11
QSY FUNCTION.....	12
Operation when Receiving a QSY.....	12
SETTING PACKET FILTER.....	12
Position Limit <POSITION LIMIT>.....	12
Packet Filter Type <TYPE>.....	12
SELECTING YOUR STATION ICON.....	13
SETTING BEACON TX ALGORITHM.....	14
Packet Transmit Method <METHOD>.....	14
TX Interval Time <TX INTERVAL>.....	14
Decay Algorithm <DECAY ALGORITHM>.....	14
Proportional Pathing <PROPORTIONAL PATHING>.....	14
PROGRAMMING A PACKET PATH.....	15
NETWORK.....	16
VOICE ALERT.....	16
WEATHER STATION DATA OUTPUT.....	16
Transmit <TX>.....	16
Transmit Interval Time <TX INTERVAL>.....	16
SETTING AS A DIGIPEATER.....	17
DIGIPEAT.....	17
UICHECK.....	17
UIDIGI.....	17
UIFLOOD.....	17
UITRACE.....	18
STORING USER PHRASES.....	18
STORING AUTO MESSAGE REPLY.....	18
Auto Answer Reply <REPLY>.....	18
Reply To Callsign <REPLY TO>.....	18
PROGRAMMING A MESSAGE GROUP CODE.....	19
SETTING SOUND.....	19
RX Beep Type <RX BEEP>.....	19
TX Beep <TX BEEP (BEACON)>.....	19
Special Call Sound <SPECIAL CALL>.....	19
APRS Voice Announce <APRS VOICE>.....	19

SETTING INTERRUPT DISPLAY.....	20	
Display Area <DISPLAY AREA>.....	20	
Automatic Brightness <AUTO BRIGHTNESS>.....	20	
Change Color <CHANGE COLOR>.....	20	
Interrupt Time <INTERRUPT TIME>	20	
SELECTING A DISPLAY UNIT (1)	20	
Speed, Distance <SPEED, DISTANCE>	20	
Altitude, Rainfall <ALTITUDE, RAIN>	20	
Temperature <TEMPERATURE>	20	
SELECTING A DISPLAY UNIT (2)	20	
Latitude longitude <POSITION>	20	
Grid Format <GRID FORMAT>.....	20	
SELECTING A NAVITRA GROUP	20	
Group Mode <GROUP MODE>	20	
Enter Group Code <GROUP CODE>	20	
STORING NAVITRA MESSAGE	21	
SETTING SmartBeaconing™.....	21	
Low speed <LOW SPEED>	21	
High speed <HIGH SPEED>.....	21	
Slow rate <SLOW RATE>.....	21	
Fast rate <FAST RATE>	21	
Turn angle <TURN ANGLE>.....	21	
Turn slope <TURN SLOPE>	21	
Turn time <TURN TIME>	21	
PACKET MONITOR DISPLAY	21	
DX PACKETCLUSTERS MONITOR	21	
Connecting TM-D710 with the HF Transceiver	21	
TRANSCEIVER RESET.....	RESET-	12_RESET_E.PDF
KEY OPERATION	1	
MENU MODE	1	
VGS-1 (OPTIONAL) OPERATION	VGS-	13_VGS_E.pdf
VOICE ANNOUNCEMENTS.....	1	
Voice Announcement Language	2	
Voice Announcement Volume.....	2	
Voice Announcement Speed.....	2	
VOICE RECORDER	2	
Voice Memos	2	
Continuous Recording.....	3	
Playback.....	3	
Playback Repeat.....	3	
Playback Repeat Interval	3	
CROSS-BAND/ LOCKED-BAND OPERATION		
(K TYPE MODELS ONLY).....	CROSS BAND REP-	14_CROSS BAND (K TYPE)_E.pdf
REPEATER OPERATION MODE.....	1	
REPEATER TX HOLD	1	
REPEATER ID TX	1	
Entering your Repeater ID	1	

WIRELESS OPERATION (K TYPE MODELS ONLY).....	WIRELESS OP-
REPARATION	1
CONTROL OPERATION	1
WEATHER ALERT (K TYPE MODELS ONLY).....	WX-
WEATHER ALERT ON/ OFF.....	1
Weather Channel	1
SKY COMMAND SYSTEM II (K AND E TYPES MODELS ONLY).....	SKY CMD-
CONNECTING THE TRANSPORTER WITH THE HF TRANSCEIVER.....	1
PREPARATION FLOW.....	2
PROGRAMMING CALLSIGNS.....	3
PROGRAMMING A TONE FREQUENCY	3
CONTROL OPERATION.....	3

15_WIRELESS (K TYPE)_E.pdf

16_WEATHER ALERT (K TYPE)_E.pdf

17_SKY COMMAND (K&E TYPES)_E.pdf

OPERATING THROUGH REPEATERS

Repeaters are often installed and maintained by radio clubs, sometimes with the cooperation of local businesses involved in the communications industry.

Compared to simplex communication, you can usually transmit over much greater distances by using a repeater. Repeaters are typically located on mountain tops or other elevated locations. They generally operate at higher ERP (Effective Radiated Power) than a typical station. This combination of elevation and high ERP allows communications over considerable distances.

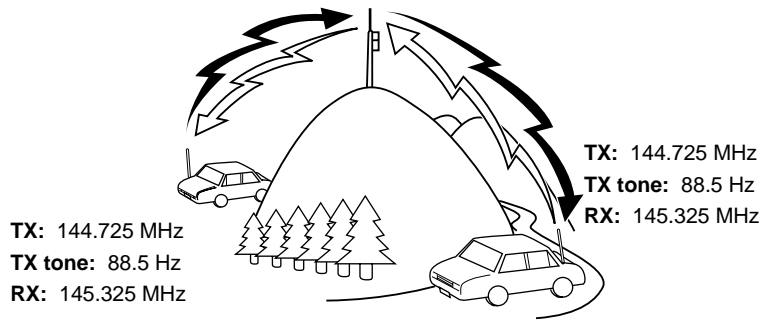

REPEATER ACCESS

Most repeaters use a receive and transmit frequency pair with a standard or non-standard offset (odd-split). In addition, some repeaters must receive a tone from the transceiver in order to gain access to the repeater. For details, consult your local repeater reference.

Selecting an Offset Direction

The offset direction allows your transmit frequency to be higher (+) or lower (-) than the receive frequency.

- 1 Select your desired band (A or B).
- 2 Press [F], [SHIFT] to select an offset direction.
 - Each time you press [SHIFT], the offset direction changes as follows:

Simplex operation $\Rightarrow + \Rightarrow - \Rightarrow$ Simplex operation

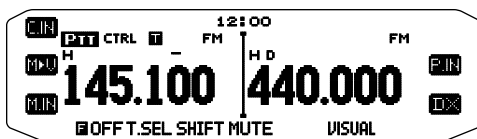
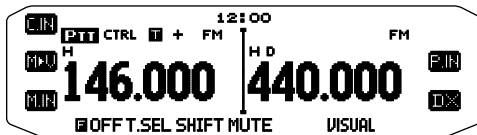

- If you are using an E type transceiver, when operating on the 430 MHz band, the offset direction changes as follows:

Simplex operation $\Rightarrow + \Rightarrow - \Rightarrow = (-7.6 \text{ MHz}) \gg$
Simplex operation

If the offset transmit frequency falls outside the allowable range, transmitting is inhibited. Use one of the following methods to bring the transmit frequency within the band limits:

- Move the receive frequency further inside the band.
- Change the offset direction.

Note: While using an odd-split memory channel or transmitting, you cannot change the offset direction.

Selecting an Offset Frequency

The offset frequency is the value which the transmit frequency will be offset from the receive frequency. The default offset frequency on the 144 MHz band is 600 kHz for all type versions. The default on the 430/440 MHz band is 5 MHz.

- 1 Select your desired band (A or B).
- 2 Enter Menu mode and access Menu 400.



- 3 Set the appropriate offset frequency value.
 - The selectable range is from 00.00 MHz to 29.95 MHz, in steps of 50 kHz.

Note: After changing the offset frequency, the new offset frequency will also be used by Automatic Repeater Offset.

Activating the Tone Function

To turn the Tone function on:

- 1 Select your desired band (A or B).
- 2 Press [TONE] to turn the Tone function ON.
 - Each time you press [TONE], the selection changes as follows:
Tone (T) \Rightarrow CTCSS (CT) \Rightarrow DCS (DCS) \Rightarrow Off (no display).
 - The T icon appears on the display when the tone function is ON.

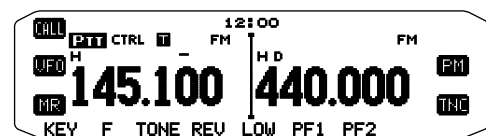

Note: When accessing a repeater that requires a 1750 Hz tone, you do not need to activate the Tone function. Simply press the key assigned to the 1750 Hz tone {Menu 507 ~ 512} to transmit the tone.

■ Selecting a Tone Frequency

To select the tone frequency required to access your desired repeater:

- 1 Turn the Tone function ON.
- 2 Press **[F]**, **[T.SEL]**.
 - The current tone frequency appears on the display. The default frequency is 88.5 Hz.

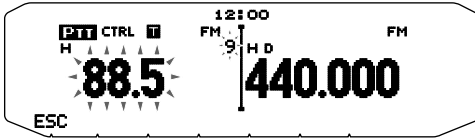

- 3 Rotate the **Tuning** control to select your desired frequency.
 - To exit the tone frequency selection, press **[ESC]**.
- 4 Press any key other than the **Tuning** control and **[ESC]** to set the selected frequency.

Note: If you have set up a Memory channel with a tone setting, simply recall the Memory channel instead of setting up the tone frequency every time.

No.	Frequency (Hz)	No.	Frequency (Hz)	No.	Frequency (Hz)
01	67.0	16	110.9	31	186.2
02	69.3	17	114.8	32	192.8
03	71.9	18	118.8	33	203.5
04	74.4	19	123.0	34	206.5
05	77.0	20	127.3	35	210.7
06	79.7	21	131.8	36	218.1
07	82.5	22	136.5	37	225.7
08	85.4	23	141.3	38	229.1
09	88.5	24	146.2	39	233.6
10	91.5	25	151.4	40	241.8
11	94.8	26	156.7	41	250.3
12	97.4	27	162.2	42	254.1
13	100.0	28	167.9		
14	103.5	29	173.8		
15	107.2	30	179.9		

■ Automatic Repeater Offset (K and E Types Only)

This function automatically selects an offset direction and activates the Tone function, according to the frequency that you have selected. To obtain an up-to-date band plan for repeater offset direction, contact your national Amateur Radio association.

- 1 Enter Menu mode and access Menu 401.
- 2 Set the ARO to ON.



- 3 Press **[BAND SEL A]** to select the A band.
- 4 Press **[VFO]** to select VFO mode.
- 5 Rotate the **Tuning** control to select your desired frequency.

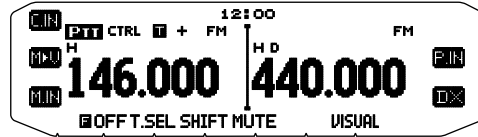

- 6 Press **[PTT]** to start a call.
 - You will be transmitting on an offset frequency value determined from your offset setting value and an offset direction depending on your selected frequency. Refer to the settings below for offset directions:

K Type:

- Under 145.100 MHz: No offset (Simplex operation)
- 145.100 ~ 145.499 MHz: Minus (-) offset
- 145.500 ~ 145.599 MHz: No offset (Simplex operation)
- 146.000 ~ 146.399 MHz: Plus (+) offset
- 146.400 ~ 146.599 MHz: No offset (Simplex operation)
- 146.600 ~ 146.999 MHz: Minus (-) offset
- 147.000 ~ 147.399 MHz: Plus (+) offset
- 147.400 ~ 147.599 MHz: No offset (Simplex operation)
- 147.600 ~ 147.999 MHz: Minus (-) offset
- 148.000 MHz and higher: No offset (Simplex operation)

E Type:

- Under 145.000 MHz: No offset (Simplex operation)
- 145.600 ~ 145.799 MHz: Minus (-) offset
- 145.800 MHz and higher: No offset (Simplex operation)

TRANSMITTING A 1750 Hz TONE

Most repeaters in Europe require that a transceiver transmit a 1750 Hz tone. On a E type model, simply pressing Microphone [CALL] causes it to transmit a 1750 Hz tone. It is also possible to program [1750] on the front panel as a PF key for transmitting a 1750 Hz tone.

Note: The transceiver continuously transmits a 1750 Hz tone until you release Microphone [CALL] or PF key(1750).

Some repeaters in Europe must receive continuous signals for a certain period of time, following a 1750 Hz tone. This transceiver is also capable of remaining in the transmit mode for 2 seconds after transmitting a 1750 Hz tone.

- 1 Enter Menu mode and access Menu 402.



- 2 Set the tone to ON or OFF.

- When set to ON, the 1750 Hz tone will transmit. When set to OFF, the tone will not be transmitted.

Note: While remaining in the transmit mode, the transceiver does not continuously transmit a 1750 Hz tone.

REVERSE FUNCTION

After setting a separate receive and transmit frequency, you can exchange these frequencies using the Reverse function. This allows you to manually check the strength of signals you receive directly from other stations, while using a repeater. If the station's signal is strong, move to a simplex frequency to continue the contact and free up the repeater.

Press [REV] to turn the Reverse function ON or OFF.

- When the Reverse function is ON, the **R** icon will appear on the display.

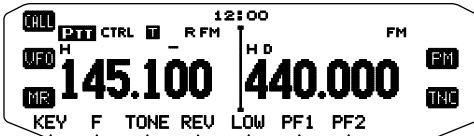

Note:

- ◆ If the transmit frequency is outside the allowable transmit frequency range when using Reverse, pressing [PTT] will cause an error tone to sound and transmission will be inhibited.
- ◆ If the receive frequency is outside the receive frequency range when using Reverse, an error tone will sound and Reverse will not operate.
- ◆ The ARO (Automatic Repeater Offset) will not function when Reverse is ON.
- ◆ You cannot switch Reverse ON or OFF while transmitting.

AUTOMATIC SIMPLEX CHECKER (ASC)

While using a repeater, ASC periodically monitors the strength of signals you receive directly from the other stations. If the station's signal is strong enough to allow direct contact without a repeater, the **R** icon blinks.

Press [REV] (1s) to turn the ASC ON.

- When the ASC is ON, the **R** icon will appear on the display.

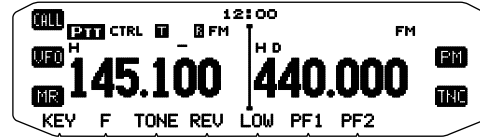

- While direct contact is possible, without the use of a repeater, the **R** icon will begin blinking.
- To exit ASC, press [REV].

Note:

- ◆ Pressing [PTT] will cause the **R** icon to stop blinking.
- ◆ ASC does not function if you are using simplex operation.
- ◆ ASC does not function while scanning.
- ◆ Activating ASC while using Reverse will switch the Reverse function OFF.
- ◆ If you recall a Memory channel or the Call channel, and those channels are set up with the Reverse function switched ON, the ASC will switch OFF.
- ◆ You cannot use ASC when the built-in TNC is turned ON.
- ◆ ASC causes received signals to be momentarily intermitted every 3 seconds.

TONE FREQUENCY ID

This function scans through all tone frequencies to identify the incoming tone frequency on a received signal. You can use this function to find which tone frequency is required by your local repeater.

- 1 Press [TONE] to switch the Tone function ON.
 - The **T** icon appears on the display.
- 2 Press [F], [T.SEL] (1s) to run the Tone Frequency ID scan.
 - The **T** icon blinks and SCAN appears on the display.

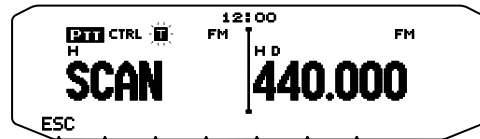

- To reverse the scan direction, turn the **Tuning** control clockwise (upward scan) or counterclockwise (downward scan).
- To quit the function, press [ESC].
- When the tone frequency is identified, the identified frequency appears on the display and blinks. Press any key other than the **Tuning** control while the identified frequency is blinking, to resume scanning.

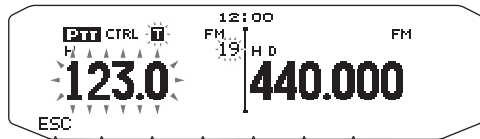

- 3 Press the **Tuning** control to program the identified frequency in place of the currently set tone frequency.
 - The Tone function will remain ON. You can press [TONE] to switch the Tone function OFF.
 - Press [ESC] if you do not want to program the identified frequency.

MEMORY CHANNELS

In Memory channels, you can store frequencies and related data that you often use. Then you need not reprogram the data every time. You can quickly recall a programmed channel by simple operation. A total of 1000 Memory channels are available for bands A and B.

SIMPLEX & REPEATER OR ODD-SPLIT MEMORY CHANNEL?

You can use each memory channel as a simplex & repeater channel or as an odd-split channel. Store only one frequency to use as a simplex & repeater channel or two separate frequencies to use as an odd-split channel. Select either application for each channel depending on the operations you have in mind.

Simplex & repeater channels allow:

- Simplex frequency operation
- Repeater operation with a standard offset (if an offset direction is stored)

Odd-split channels allow:

- Repeater operation with a non-standard offset

The data listed below can be stored in each Memory channel:

Parameter	Simplex & Repeater	Odd-split
Receive frequency	Yes	Yes
Transmit frequency		Yes
Receive frequency step size	Yes	Yes
Transmit frequency step size		Yes
Offset direction	Yes	No
Tone ON/OFF	Yes	Yes
Tone frequency	Yes	Yes
CTCSS ON/OFF	Yes	Yes
CTCSS frequency	Yes	Yes
DCS ON/OFF	Yes	Yes
DCS code	Yes	Yes
Reverse ON/OFF	Yes	No
Memory channel lockout	Yes	Yes
Memory channel name	Yes	Yes
Modulation/ Demodulation mode	Yes	Yes

STORING SIMPLEX AND STANDARD REPEATER FREQUENCIES

- 1 Press **[VFO]** to enter VFO mode.
- 2 Rotate the **Tuning** control to select your desired frequency.
 - Additionally, you can press the microphone **[UP]/[DWN]** keys to select a frequency.
- 3 Set up any additional data desired for the frequency.
 - Offset direction, Tone ON/OFF, Tone frequency, CTCSS ON/OFF, CTCSS frequency, DCS ON/OFF, DCS code, etc.
- 4 Press **[F]**.
 - A memory channel number appears.

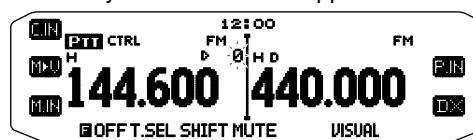

- 5 Rotate the **Tuning** control to select your desired channel number.
 - When the selected channel does not have stored data, the “**D**” icon appears. When the channel does have stored data, the “**M**” icon appears.
 - Additionally, you can press the microphone **[UP]/[DWN]** keys to select a channel.
- 6 Press **[M.IN]** to store the data in the selected Memory channel.

Note: If you store the data in a Memory channel that already has data stored in it, the old data will be cleared and the new data will be stored.

■ Call Channel Memory (Simplex)

The Call channel can be used to store any frequency and related data that you will recall often. You may want to dedicate the Call channel as an emergency channel within your group.

To store a simplex frequency and related data as the Call channel instead of in a Memory channel, after step 4 (above), press **[C.IN]**.

Note: Storing new data in the Call channel will clear the old data. (The Call channel itself cannot be cleared, but data can be replaced with new data.)

STORING ODD-SPLIT REPEATER FREQUENCIES

Some repeaters use a receive and transmit frequency pair with a non-standard offset. To access those repeaters, store two separate frequencies in a memory channel. You can then operate on those repeaters without changing the offset frequency you stored in the menu.

- 1 Set up a simplex channel by following steps 1 to 6 of "STORING SIMPLEX AND STANDARD REPEATER FREQUENCIES", above.
- 2 Press **[VFO]** to enter VFO mode.
- 3 Rotate the **Tuning** control to select your desired transmit frequency.
 - Additionally, you can press the microphone **[UP]/[DWN]** keys to select a frequency.
- 4 Set up any additional data desired for the transmit frequency.
 - Tone ON/OFF, Tone frequency, CTCSS ON/OFF, CTCSS frequency, DCS ON/OFF, DCS code, etc.
- 5 Press **[F]**.
 - A memory channel number appears.
- 6 Rotate the **Tuning** control to select your desired channel number.
 - Additionally, you can press the microphone **[UP]/[DWN]** keys to select a channel.

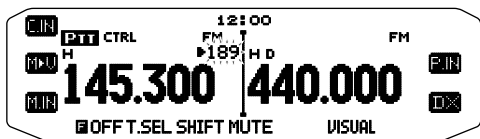

- 7 Press **[PTT]**, **[M.IN]** to store the data in the selected Memory channel.

■ Call Channel Memory (Odd-Split)

The Call channel can be used to store any frequency and related data that you will recall often. You may want to dedicate the Call channel as an emergency channel within your group.

To store an odd-split frequency and related data as the Call channel instead of in a Memory channel, after step 6 (above), press **[PTT]**, **[C.IN]**.

Note:

- ◆ You cannot set the transmission and reception frequencies on different bands.
- ◆ You cannot set a different frequency step size for the transmission and reception frequencies.
- ◆ You cannot store the transmit offset status and Reverse status in an odd-split Call channel.

RECALLING A MEMORY CHANNEL

- 1 Press **[MR]** to enter Memory Recall mode.
- 2 Rotate the **Tuning** control to select your desired Memory channel.
 - Additionally, you can press the microphone **[UP]/[DWN]** keys to select a channel, or you can enter a channel number using the microphone keypad.

■ Memory Recall Method

The transceiver Menu also provides you with the option to recall Memory channels with stored frequencies in your current band, or all Memory channels:

- 1 Enter Menu mode and access Menu 201.



- 2 Set the recall method to CURRENT (current band) or ALL BANDS (all bands).
 - CURRENT allows you to recall only those memory channels that have stored frequencies within the current band. ALL allows you to recall all programmed memory channels.
 - When the recalled memory channel is an AM channel, you cannot recall on the B band.

Frequency ranges:

- 118 MHz: 118 ~ 135.995 MHz
- 144 MHz: 136 ~ 199.995 MHz
- 220 MHz: 200 ~ 299.995 MHz
- 300 MHz: 300 ~ 399.995 MHz
- 430/440 MHz: 400 ~ 523.995 MHz
- 1200 MHz: 800 ~ 1299.990 MHz

CLEARING A MEMORY CHANNEL

- 1 Press **[MR]** to enter Memory Recall mode.
- 2 Rotate the **Tuning** control to select your desired Memory channel.
 - Additionally, you can press the microphone **[UP]/[DWN]** keys to select a channel, or you can enter a channel number using the microphone keypad.

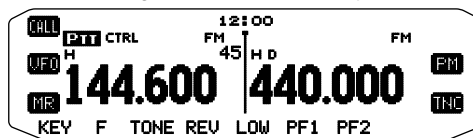

- 3 Turn the transceiver power OFF.
- 4 Press **[MR] + Power ON**.
 - A confirmation message appears on the display.



- 5 Press the **Tuning** control to clear the Memory channel.
 - To exit without clearing the channel, press **[ESC]**.

NAMING A MEMORY CHANNEL

You can name Memory channels using up to 8 characters. When you recall a named Memory channel, its name appears on the display. Names can be callsigns, repeater names, cities, people, etc.

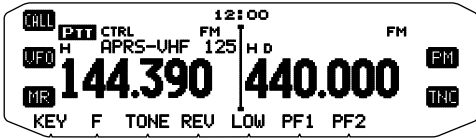

- 1 Press **[MR]** to enter Memory Recall mode.
- 2 Rotate the **Tuning** control to select your desired Memory channel.
- 3 Enter Menu mode and access Menu 200.



- 4 Enter your desired name for the channel.

Note: You can overwrite a Memory channel name by performing the steps above. You can also clear a Memory channel name by clearing the Memory channel.

MEMORY-TO-VFO TRANSFER

Transferring the contents of a Memory channel or the Call channel to the VFO can be useful if you want to search for other stations or a clear frequency, near the selected Memory channel or Call channel frequency.

- 1 Press **[MR]** or **[CALL]** to enter Memory Recall mode or select the Call channel.
- 2 Rotate the **Tuning** control to select your desired channel. (This step is not necessary when selecting the Call channel.)
- 3 Press **[F]**, **[M>V]**.
 - The entire contents of the Memory channel or Call channel are copied to the VFO, and VFO mode is selected after the transfer is complete.
 - When copying a transmit frequency from an odd-split Memory or Call channel, you must first turn the Reverse function ON before pressing **[F]**, **[M>V]**.

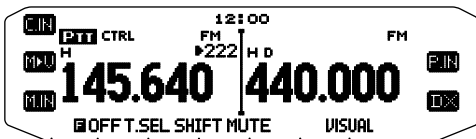

CHANNEL DISPLAY FUNCTION

Use this function when you want to use only Memory channels. When this function is switched ON, the transceiver displays only a Memory channel number instead of a frequency.

- 1 Turn the transceiver power OFF.
- 2 Press **[LOW]** + **Power ON** to turn the channel display ON or OFF.

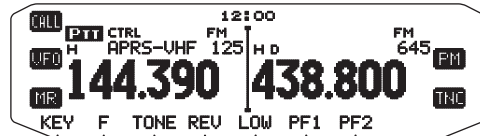
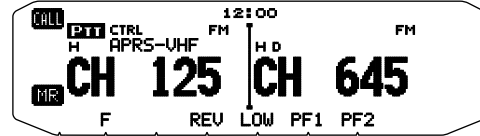

Note:

- ◆ If no Memory channels have saved data in them, channel display will not function.
- ◆ When using Channel Display, you cannot reset the transceiver.

While in Channel Display mode, the transceiver keys function as shown next page:

Key Name	[KEY]	[F], [KEY]	[KEY] (1s)	While Transmitting	[KEY] + Power ON
	Power ON/OFF	Power ON/OFF	Power ON/OFF	Power ON/OFF	X
PM	–	–	–	–	–
TNC	–	DX PacketClusters Monitor ON/OFF	–	–	–
CALL	Call mode	–	Call Scan	–	–
VFO	–	–	–	–	–
MR	MR mode	–	Memory Scan	–	–
KEY	–	–	–	–	–
F	Function mode	Exit Function mode	Key Lock	–	Reset
TONE	–	–	–	–	–
REV	Reverse ON/OFF	–	–	–	–
LOW/ MUTE	Change output power	Mute	–	Change output power	Change channel display
PF1	Select the Weather channel (K type)	–	–	–	–
PF2	Change control band (default)	–	–	–	–
Tuning control	–	–	Group Scan	–	–
BAND SEL A	A band	–	Change Single/Dual	–	–
BAND SEL B	B band	–	Change Single/Dual	–	–

PROGRAMMABLE MEMORY (PM)

Programmable Memory (PM) stores virtually all settings currently set on the transceiver. This transceiver provides 5 PM channels to store 5 sets of transceiver configurations. Later, you can quickly recall any one of these channels, depending on the operations you have in mind or the operating environment.

The following programmable settings cannot be stored:

- Memory name
- Memory channel lockout
- Channel Display mode
- Locked-band/ Cross-band Repeater ON/OFF ¹
- Repeater mode ¹
- Repeater hold ¹
- Repeater ID transmit ¹
- Registered repeater ID ¹
- Wireless remote control ¹
- Answer back ¹
- Remote control ID ¹
- Key lock
- Power on password ²
- Memory channel/ Call channel/ Program scan memory
- Weather channel ¹
- DTMF memory
- EchoLink memory
- COM port speed
- PC port speed
- Microphone sensitivity
- 10 MHz mode ²
- Input/output level (DATA terminal) ²
- SQC data output logic ²

¹ K type only

² Can be set only by using the MCP-2A software.

APPLICATION EXAMPLES

The following are examples of how you might use Programmable Memory. These examples may not represent applications useful to you, but you will understand the flexibility of this function.

Situation: You share your transceiver with other members in your family or club. However, each individual has personal preferences for how they like to set various functions. You have to keep changing many settings each time you use the transceiver.

Solution: Because 5 PM channels are available, up to 5 persons can separately program the transceiver and store their customized environment. Then each person can quickly change to his or her favorite settings, simply by recalling a PM channel. It is too much trouble to change back the settings after somebody else has reconfigured them. So this application may avoid having a feature-rich transceiver but never using many useful features.

Situation: While operating mobile on the way to work every morning, you prefer a silent transceiver that does not interrupt the morning calm. In addition, you feel that a bright display is useless in the sunlight. At night when driving home, you realize the Beep function truly does serve a purpose and you acknowledge it is nice to see a bright display after dark.

Solution: In 2 PM channels, store the same operating data such as frequency, offset, tone, etc, and store different settings for the Display brightness and Beep functions. Then you can quickly recall the best settings for day or night operation.

Situation: You cannot figure out how to exit the current transceiver mode.

Solution: Simply recall PM channel 1, which contains an exact copy of the transceiver default environment. You will not lose the contents of any memory channels.

STORING DATA IN PM CHANNELS

- 1 Confirm that the following conditions have been satisfied:
 - The transceiver is in receive mode.
 - Scan is not being used.
 - Microphone Control is OFF.
- 2 Configure the transceiver with your desired settings.
- 3 Press **[F]**, **[P.IN]**.
 - PM channel numbers 1 to 5 appear and blink at the bottom of the display.

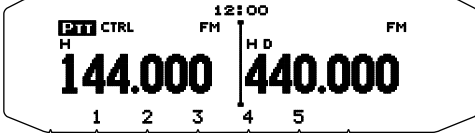

- 4 Enter a channel number (**[1]** to **[5]**) corresponding to your desired PM channel.
 - The settings are stored in the PM channel.

RECALLING PM CHANNELS

- 1 Press **[PM]**.
 - PM channel numbers 1 to 5 and OFF appear on the bottom of the display.

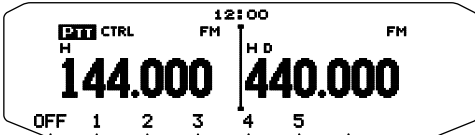

- 2 Enter a channel number (**[1]** to **[5]**) corresponding to your desired PM channel.
 - The settings stored in the PM channel are recalled.
 - The selected channel number appears on the display.
 - When selecting **[OFF]**, the PM channels turn off.



AUTO PM CHANNEL STORE

After you recall a PM channel, this function automatically overwrites the current PM channel with the present operating environment when:

- You recall another PM channel.
- You press **[PM]**.
- You switch the transceiver power OFF.

Follow the steps below to activate the Auto PM storage function.

- 1 Enter Menu mode and access Menu 521.



- 2 Set to ON.

Note: If you do not recall a PM channel (1 - 5), Menu No. 521 will not appear on the display.

PM CHANNEL RESET

To reset the PM channels to their default settings:

- 1 Turn the transceiver power OFF.
- 2 Press **[F]** + **Power ON**.
- 3 Release **[F]**.
- 4 Rotate the **Tuning** control and select **PM RESET**.



- 5 Press the **Tuning** control.
 - A confirmation message appears on the display.



- 6 Press the **Tuning** control again to reset the PM channels.
 - Press **[BACK]** to return to the previous display.
 - To exit without resetting the PM channels, press **[ESC]**.

SCAN

Scan is a useful feature for hands-off monitoring of your favorite frequencies. Becoming comfortable with all types of Scan will increase your operating efficiency.

This transceiver provides the following types of scans:

Scan Type	Scan Range
VFO Scan	Scans all frequencies on the current band.
Memory Scan	Scans all frequencies stored in the Memory channels.
Group Scan	Scans the frequencies in the Memory channels which belong to the group you have specified.
Program Scan	Scans all frequencies within the programmed range, on the current band.
MHz Scan	Scans all frequencies within a 1 MHz range from the originating frequency.
Call Scan	Scans the Call channel as well as the currently selected VFO frequency or Memory channel.

- Note:**
- ◆ Adjust the squelch level before using Scan. Selecting a squelch level too low could cause Scan to stop immediately.
 - ◆ While using CTCSS or DCS, Scan stops for any signal received; however, you will hear audio only when the signal contains the same CTCSS tone or DCS code that you selected.
 - ◆ When using S-meter Squelch, Scan stops when the received signal strength matches or exceeds the S-meter setting. Scan resumes 2 seconds after the signal level drops below the S-meter setting.
 - ◆ Pressing and holding [PTT] causes Scan to temporarily stop if it is functioning on a non TX band.
 - ◆ Starting Scan switches the Automatic Simplex Checker OFF.

SELECTING A SCAN RESUME METHOD

The transceiver stops scanning at a frequency or Memory channel on which a signal is detected. It then continues scanning according to which resume mode you have selected. You can choose one of the following modes. The default is Time-operated mode.

- **Time-Operated mode**
The transceiver remains on a busy frequency or Memory channel for approximately 5 seconds, and then continues to scan even if the signal is still present.
- **Carrier-Operated mode**
The transceiver remains on a busy frequency or Memory channel until the signal drops out. There is a 2 second delay between signal drop-out and scan resumption.
- **Seek mode**
The transceiver remains on a busy frequency or Memory channel even after the signal drops out and does not automatically resume scanning.

Note: To temporarily stop scanning and monitor weak signals, press the microphone PF key assigned to the Monitor function. Press the PF key again to resume scanning.

- 1 Enter Menu mode and access Menu 514.



- 2 Set the Scan Resume mode to TIME (Time-Operated), CARRIER (Carrier-Operated) or SEEK.

VFO SCAN

VFO Scan monitors all frequencies tunable on the band, using the current frequency step size.

- 1 Select your desired band.
- 2 Press [VFO] (1s).
 - Scan starts at the current frequency.
 - The 1 MHz decimal blinks while scanning is in progress.
 - To reverse the scan direction, turn the **Tuning** control clockwise (upward scan) or counterclockwise (downward scan). You can also press microphone [UP]/ [DWN].
- 3 To quit VFO Scan, press [VFO] again.

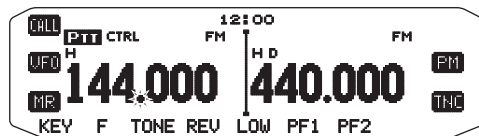

MEMORY SCAN

Use Memory Scan to monitor all Memory channels programmed with frequency data.

- 1 Select your desired band.
- 2 Press **[MR]** (**1s**).
 - v Scan starts at the current frequency.
 - The 1 MHz decimal blinks while scanning is in progress.
 - To reverse the scan direction, turn the **Tuning** control clockwise (upward scan) or counterclockwise (downward scan). You can also press microphone **[UP]/ [DWN]**.
- 3 To quit Memory Scan, press **[MR]** again.

Note:

- ◆ At least 2 Memory channels must contain data and must not be locked out of scan.
- ◆ The L0/U0 to L9/U9 Memory channels will not be scanned.
- ◆ You can also start Memory Scan when in Channel Display mode. While Scan is paused on a channel, the channel number blinks.

Locking Out a Memory Channel

You can select Memory channels that you prefer not to monitor while scanning.

- 1 Press **[MR]**, then rotate the **Tuning** control to select your desired channel.
- 2 Enter Menu mode and access Menu 202.



- 3 Set the lockout to ON to lock the channel out of the scanning sequence.
 - To cancel lockout, set the lockout to OFF.
 - The ★ icon appears on the display for a channel that has been locked out.

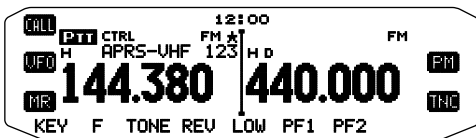

Note: The L0/U0 to L9/U9 Memory channels cannot be locked out.

GROUP SCAN

For the purpose of Group Scan, the 1000 Memory channels are divided into 10 groups, with each group containing 100 channels. Group Scan monitors only the 100 channels which belong to the specific group you are scanning. The channels are grouped as follows:

Memory Group	Channel Range	Memory Group	Channel Range
0	0 ~ 99	5	500 ~ 599
1	100 ~ 199	6	600 ~ 699
2	200 ~ 299	7	700 ~ 799
3	300 ~ 399	8	800 ~ 899
4	400 ~ 499	9	900 ~ 999

- 1 Press **[MR]**, then rotate the **Tuning** control to select a channel in your desired group.
- 2 Press the **Tuning** control (**1s**).
 - Scan starts at the current channel.
 - The 1 MHz decimal blinks while scanning is in progress.
 - To reverse the scan direction, turn the **Tuning** control clockwise (upward scan) or counterclockwise (downward scan). You can also press microphone **[UP]/ [DWN]**.
- 3 To quit Group Scan, press the **Tuning** control again.

Note:

- ◆ At least 2 Memory channels in the selected group must contain data and must not be locked out of scan.
- ◆ You can also start Memory Scan when in Channel Display mode. While Scan is paused on a channel, the channel number blinks.

Memory Group Link

Memory Group Link provides you with the ability to link 2 or more Memory channel groups together to act as a single group when scanning. You can link up to 10 separate groups together, or even add multiple instances of the same group to the group link, to ensure that one group is scanned more often than the other groups.

- 1 Enter Menu mode and access Menu 203.
- 2 Press the **Tuning** control.
 - The cursor will begin blinking.



- 3 Rotate the **Tuning** control to select a group to link.
- 4 Press the **Tuning** control to set the group and move the cursor to the right.
 - Press **[←]** to move the cursor back or **[→]** to move the cursor to the right.
- 5 Repeat steps 3 and 4 to link additional groups together.



- 6 When you have entered your desired groups, press **[→]** to move the cursor to the right, then press the **Tuning** control to complete the entry and exit Menu mode.
 - You can insert one space by pressing **[SPACE]**.
 - You can insert a character by pressing **[INS]**.
 - You can delete the selected character by pressing **[CLR]**.
 - If you have entered the maximum of 6 groups, simply press the **Tuning** control to complete the entry and exit Menu mode.

PROGRAM SCAN

Program Scan is identical to VFO Scan except that you select a frequency range for the scan.

■ Setting Scan Limits

You can store up to 10 scan ranges in Memory channels L0/U0 to L9/U9.

- 1 Press **[VFO]**.
- 2 Select your desired band.
- 3 Rotate the **Tuning** control to select your desired frequency for the lower limit.

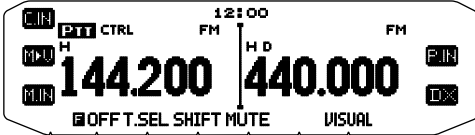

- 4 Press **[F]**.
 - A memory channel number appears and blinks.
- 5 Rotate the **Tuning** control to select a channel from L0 to L9.

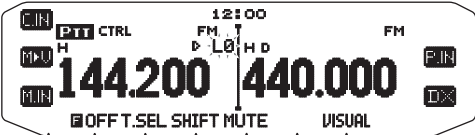

- 6 Press **[M.IN]** to set the channel number.
 - The lower limit is stored in the channel.
- 7 Rotate the **Tuning** control to select your desired frequency for the lower limit.
- 8 Press **[F]**.
- 9 Rotate the **Tuning** control to select a matching channel number from U0 to U9.
 - For example, if you select channel L3 in step 5, select channel U3 here.
- 10 Press **[M.IN]** to set the channel number.
 - The upper limit is stored in the channel.
 - To confirm the stored scan limits, press **[MR]**, then select the L and U channels.

Note:

- ◆ The lower limit must be lower in frequency than the upper limit.
- ◆ The lower and upper frequency step sizes must be equal.
- ◆ The lower and upper limits must be selected on the same band.

■ Using Program Scan

- 1 Select your desired band.
- 2 Press **[VFO]**.
- 3 Rotate the **Tuning** control to select a frequency within your desired scan range.
- 4 Press **[VFO] (1s)**.
 - Scan starts at the current frequency.
 - The 1 MHz decimal blinks while scanning is in progress.
 - To reverse the scan direction, turn the Tuning control clockwise (upward scan) or counterclockwise (downward scan). You can also press microphone **[UP]/ [DWN]**.
- 5 To quit Program Scan, press **[VFO]** again.

Note:

- ◆ If the step size differs between the lower limit and upper limit, VFO scan will begin instead of Program Scan.
- ◆ If the current VFO frequency is within more than one Program Scan range, the range stored in the smallest channel number is used.

MHz SCAN

MHz Scan monitors a 1 MHz segment of the band, using the current frequency step size. The current 1 MHz digit determines the limits of the scan. For example, if the current frequency is 145.400 MHz, then the scan range would be from 145.000 MHz to 145.995 MHz (the exact upper limit depends on the current frequency step size).

- 1 Select your desired band.
- 2 Press **[VFO]**.
- 3 Rotate the **Tuning** control to select a frequency within your desired 1 MHz range.
- 4 Press and hold the **Tuning** control for 1 second to start scanning.
 - Scan starts at the current frequency.
 - The 1 MHz decimal blinks while scanning is in progress.
 - To reverse the scan direction, turn the **Tuning** control clockwise (upward scan) or counterclockwise (downward scan). You can also press microphone **[UP]/ [DWN]**.
- 5 To quit MHz Scan, press the **Tuning** control again.

CALL SCAN

Use Call Scan to monitor both the Call channel and either the currently selected VFO frequency or the currently selected Memory channel.

- 1 Select your desired VFO frequency or Memory channel.
- 2 Press **[CALL] (1s)** to start Call Scan.
 - The 1 MHz decimal blinks while scanning is in progress.
 - When scanning a Memory channel, the Call channel on the same band as the selected Memory channel is used for scan.
- 3 To quit Call Scan, press **[CALL]** again.

Note: The Memory channel selected is scanned even if it has been locked out of scan.

VISUAL SCAN

While you are receiving, Visual Scan allows you to monitor frequencies near the current operating frequency. Visual Scan graphically and simultaneously shows how all frequencies in the selected range are busy. You will see up to 21 segments, for each channel, that represent 7 S-meter levels (3 segments per level).

Determine the scan range by selecting the center frequency and the number of channels. The default number of channels is 61.

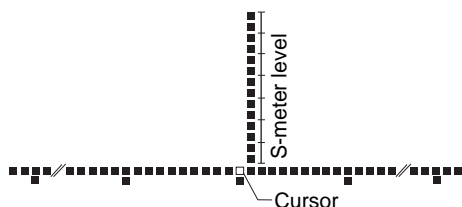

■ Selecting the Number of Channels

- 1 Enter Menu mode and access Menu 515.

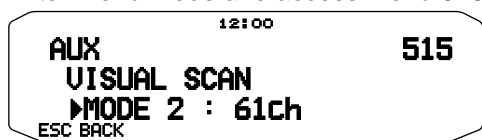

- 2 Set the number of channels to MODE 1 (31ch), MODE 2 (61ch), MODE 3 (91ch), or MODE 4 (181ch).

■ Using Visual Scan

- 1 Select your desired band.
- 2 Rotate the **Tuning** control select the operating frequency.
 - This frequency will be used as the center frequency.
- 3 Press **[F]**, **[VISUAL]** to start Visual Scan.

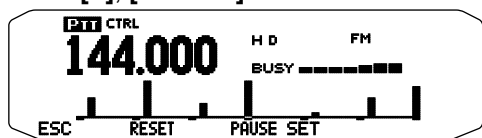

- To halt Scan, press **[PAUSE]**. "PAUSE" appears and blinks. Press **[PAUSE]** again to resume.
- 4 To change the operating frequency, rotate the **Tuning** control.
 - The displayed frequency changes and the cursor moves.
 - Press **[SET]** to use the changed operating frequency as the center frequency.
 - Press **[RESET]** to restore the previous operating frequency.
 - 5 To exit Visual Scan, press **[ESC]**.

Note:

- ◆ You cannot use the Visual Scan Function under the following circumstances:
 - When the APRS/NAVITRA or Packet mode is turned ON.
 - When only 1 channel has been stored in the memory channels.
 - When using Weather Alert (K models only).
- ◆ If you start Visual Scan in Memory Recall mode, the memory channel frequencies will be scanned.
- ◆ If you start Visual Scan after recalling the Call channel, the Call channel frequency will be used as the center frequency.
- ◆ If the frequency range specified for Program Scan or Program VFO is narrower than the range specified for Visual Scan, the range for Program Scan or VFO will be used for Visual Scan.
- ◆ Visual Scan stops while transmitting.
- ◆ If you start Visual Scan in one of the following conditions, you cannot receive in the current operating frequency. To use this frequency, press **[PAUSE]** to halt Scan.
 - Memory Recall or Call Channel mode.
 - A frequency in the 118, 220, 300, or 1200 MHz band was selected in VFO mode.
- ◆ Depending on the transceiver conditions, Visual Scan and the conventional S-meter may indicate different signal strength levels.

CONTINUOUS TONE CODED SQUELCH SYSTEM (CTCSS)

You may sometimes want to hear calls only from specific persons. The Continuous Tone Coded Squelch System (CTCSS) allows you to ignore (not hear) unwanted calls from other persons who are using the same frequency. To do so, select the same CTCSS tone as selected by the other persons in your group. A CTCSS tone is subaudible and is selectable from among 42 tone frequencies.

Note: CTCSS does not cause your conversation to be private. It only relieves you from listening to unwanted conversations.

USING CTCSS

- 1 Select your desired band.
- 2 Press **[TONE]** 2 times to activate the CTCSS function.
 - The **CT** icon appears on the display when the CTCSS function is ON.
 - Each press of **[TONE]** changes the selection as follows: Tone (**T**) → CTCSS (**CT**) → DCS (**DCS**) → Off (no display).

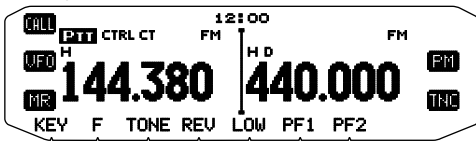

- 3 Press **[F]**, **[T.SEL]**.
 - The current CTCSS frequency appears on the display and blinks.

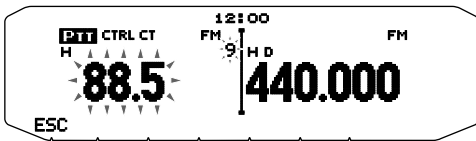

- 4 Rotate the **Tuning** control to select your desired CTCSS frequency.
 - Refer to the table below for the available frequencies.
 - To exit the CTCSS frequency selection, press **[ESC]**.
- 5 Press any key other than the **Tuning** control and **[ESC]** to complete the setting.
- 6 **When you are called:** The transceiver squelch opens only when the selected CTCSS tone is received.
When you make a call: Press and hold **[PTT]**, then speak into the microphone.
 - To cancel CTCSS, press **[TONE]** until CT no longer appears on the display.

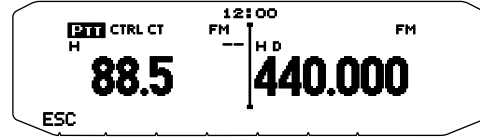

- 5 Enter a frequency reference number (01 ~ 42) using the microphone keypad.
 - Refer to the table below for frequencies and their reference numbers.

No.	Frequency (Hz)	No.	Frequency (Hz)	No.	Frequency (Hz)
01	67.0	16	110.9	31	186.2
02	69.3	17	114.8	32	192.8
03	71.9	18	118.8	33	203.5
04	74.4	19	123.0	34	206.5
05	77.0	20	127.3	35	210.7
06	79.7	21	131.8	36	218.1
07	82.5	22	136.5	37	225.7
08	85.4	23	141.3	38	229.1
09	88.5	24	146.2	39	233.6
10	91.5	25	151.4	40	241.8
11	94.8	26	156.7	41	250.3
12	97.4	27	162.2	42	254.1
13	100.0	28	167.9		
14	103.5	29	173.8		
15	107.2	30	179.9		

You can also select a CTCSS frequency by using the microphone:

- 1 Select your desired band.
- 2 Press **[TONE]** 2 times to activate the CTCSS function.
 - The **CT** icon appears on the display when the CTCSS function is ON.
 - Each press of **[TONE]** changes the selection as follows: Tone (**T**) → CTCSS (**CT**) → DCS (**DCS**) → Off (no display).
- 3 Press **[F]**, **[T.SEL]**.
 - The current CTCSS frequency appears on the display and blinks.
- 4 Press the key programmed as **[ENTER]**.

CTCSS FREQUENCY SCAN

This function scans through all CTCSS frequencies to identify the incoming CTCSS frequency on a received signal. You may find this useful when you cannot recall the CTCSS frequency that the other persons in your group are using.

1 Press **[TONE]** 2 times to activate the CTCSS function.

- The **CT** icon appears on the display when the CTCSS function is ON.
- Each press of **[TONE]** changes the selection as follows:
Tone (**T**) → CTCSS (**CT**) → DCS (**DCS**) → Off (no display).

2 Press **[F]**, **[T.SEL]** (1s).

- The **CT** icon blinks and "SCAN" appears on the display.
- Scan starts when a signal is received.

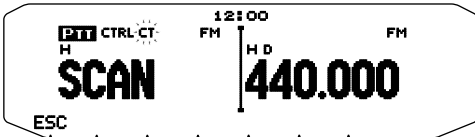

- To reverse the scan direction, turn the **Tuning** control clockwise (upward scan) or counterclockwise (downward scan). You can also press microphone **[UP]**/**[DWN]**.
- To quit the scan, press **[ESC]**.
- When a CTCSS frequency is identified, the identified frequency appears on the display and blinks.

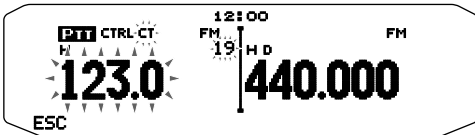

3 Press the **Tuning** control to program the identified frequency in place of the currently set CTCSS frequency.

- The CTCSS function will remain ON. To cancel CTCSS, press **[TONE]** until CT no longer appears on the display.
- Press **[ESC]** if you do not want to program the identified frequency.
- Rotate the **Tuning** control while an identified frequency is blinking, to resume scanning.

DIGITAL CODED SQUELCH (DCS)

Digital Code Squelch (DCS) is another application which allows you to ignore (not hear) unwanted calls. It functions the same way as CTCSS. The only differences are the encode/ decode method and the number of selectable codes. For DCS, you can select from 104 different codes.

USING DCS

- Select your desired band.
- Press **[TONE]** 3 times to activate the DCS function.
 - The **DCS** icon appears on the display when the DCS function is ON.
 - Each press of **[TONE]** changes the selection as follows: Tone (**T**) → CTCSS (**CT**) → DCS (**DCS**) → Off (no display).

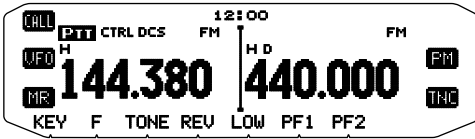

- Press **[F]**, **[T.SEL]**.
 - The current DCS code appears on the display and blinks.

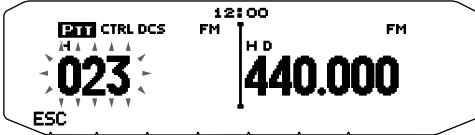

- Rotate the **Tuning** control to select your desired DCS code.
 - Refer to the table below for the available codes.
 - To exit the DCS code selection, press **[ESC]**.
- Press any key other than the **Tuning** control and **[ESC]** to complete the setting.
- When you are called:** The transceiver squelch opens only when the selected DCS code is received.
When you make a call: Press and hold **[PTT]**, then speak into the microphone.
 - To cancel DCS, press **[TONE]** until DCS no longer appears on the display.

You can also select a DCS code by using the microphone:

- Select your desired band.
- Press **[TONE]** 3 times to activate the DCS function.
 - The **DCS** icon appears on the display when the DCS function is ON.
 - Each press of **[TONE]** changes the selection as follows: Tone (**T**) → CTCSS (**CT**) → DCS (**DCS**) → Off (no display).
- Press **[F]**, **[T.SEL]**.
 - The current DCS code appears on the display and blinks.
- Press the key programmed as **[ENTER]**.

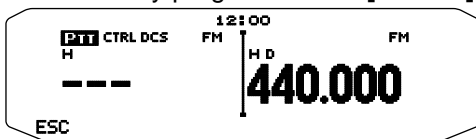

- Enter your desired DCS code using the microphone keypad.
 - Refer to the table below for DCS codes.

DCS Code							
023	025	026	031	032	036	043	047
051	053	054	065	071	072	073	074
114	115	116	122	125	131	132	134
143	145	152	155	156	162	165	172
174	205	212	223	225	226	243	244
245	246	251	252	255	261	263	265
266	271	274	306	311	315	325	331
332	343	346	351	356	364	365	371
411	412	413	423	431	432	445	446
452	454	455	462	464	465	466	503
506	516	523	526	532	546	565	606
612	624	627	631	632	654	662	664
703	712	723	731	732	734	743	754

DCS CODE SCAN

This function scans through all DCS codes to identify the incoming DCS code on a received signal. You may find it useful when you cannot recall the DCS code that the other persons in your group are using.

- Press **[TONE]** 3 times to activate the DCS function.
 - The **DCS** icon appears on the display when the DCS function is ON.
 - Each press of **[TONE]** changes the selection as follows: Tone (**T**) → CTCSS (**CT**) → DCS (**DCS**) → Off (no display).
- Press **[F]**, **[T.SEL]** (1s).
 - The **DCS** icon blinks and "SCAN" appears on the display.
 - Scan starts when a signal is received.

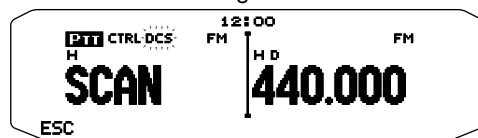

- To reverse the scan direction, turn the **Tuning** control clockwise (upward scan) or counterclockwise (downward scan). You can also press microphone **[UP]**/ **[DWN]**.
- To quit the scan, press **[ESC]**.
- When a DCS code is identified, the identified code appears on the display and blinks.

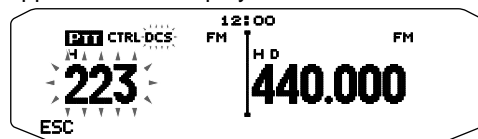

- Press the **Tuning** control to program the identified code in place of the currently set DCS code.
 - The DCS function will remain ON. To cancel DCS, press **[TONE]** until DCS no longer appears on the display.
 - Press **[ESC]** if you do not want to program the identified code.
 - Rotate the **Tuning** control while an identified code is blinking, to resume scanning.

DUAL TONE MULTI-FREQUENCY (DTMF)

The keys on the microphone keypad function as DTMF keys; the 12 keys found on a push-button telephone plus 4 additional keys (A, B, C, D). This transceiver provides 10 dedicated memory channels. You can store a DTMF code with up to 16 digits.

Some repeaters in the U.S.A. and Canada offer a service called Autopatch. You can access the public telephone network via such a repeater by sending DTMF tones. For further information, consult your local repeater reference.

MANUAL DIALING

Manual Dialing requires only two steps to send DTMF tones.

- 1 Press and hold the microphone **[PTT]**.
- 2 Press the keys in sequence on the keypad to send DTMF tones.
 - The corresponding DTMF tones are transmitted.
 - If the DTMF Hold function is activated, you need not hold down **[PTT]** while pressing keys. After transmitting the first tone (by pressing **[PTT]** and the first key), pressing additional keys will keep the transceiver in transmit mode for 2 seconds.

Frequency (Hz)	1209	1336	1447	1633
697	[1]	[2]	[3]	[A]
770	[4]	[5]	[6]	[B]
852	[7]	[8]	[9]	[C]
941	[*]	[0]	[#]	[D]

■ DTMF Hold

Activate this function to remain in transmit mode, after beginning to press keys when making a call.

- 1 Enter Menu mode and access Menu 300.

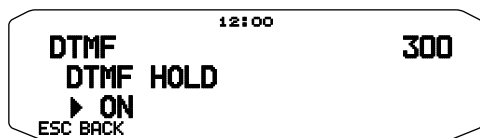

- 2 Set DTMF Hold to ON to continue transmitting when pressing keys.
 - Set this menu to OFF to stop the 2 second continuous transmission.

AUTOMATIC DIALER

There are 10 dedicated DTMF Memory channels available to store DTMF codes. You can store up to 16 digits in each channel.

■ Storing a DTMF Code in Memory

- 1 Enter Menu mode and access Menu 301.

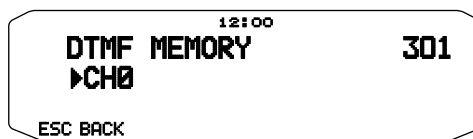

- 2 Rotate the **Tuning** control to select a channel number.
- 3 Press the **Tuning** control to set the selected channel number.
 - The name entry display appears.



- 4 Enter a name for the channel, then press the **Tuning** control to set it.
 - The code entry display appears.



- 5 Enter a DTMF code for the channel, then press the **Tuning** control to set it.
 - When a space is entered, it becomes a "Pause" code.

■ Transmitting Stored DTMF Codes

- 1 Press and hold the microphone [PTT].
- 2 While transmitting, press the **Tuning** control.
 - The last called DTMF Memory channel name and number appear on the display. If no name has been saved for the channel, the DTMF code appears.

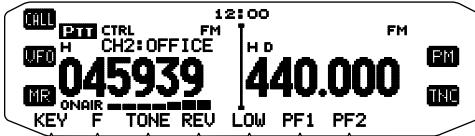

- 3 While still transmitting, rotate the **Tuning** control to select your desired DTMF Memory channel, then press the **Tuning** control to set the channel.
 - Additionally, you can press a DTMF key corresponding to your desired channel ([0] ~ [9]) to select the channel and begin transmission.
 - The stored DTMF code scrolls across the display and is transmitted.
 - The code will be transmitted even if you release [PTT] before the entire code has scrolled across the display.
 - If no DTMF code is stored in the selected channel, the frequency display is restored.

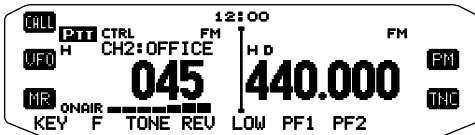
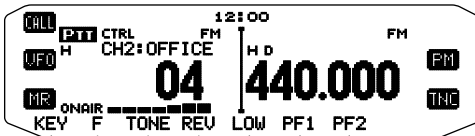
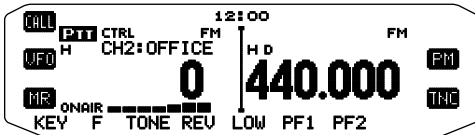

■ Selecting a Transmit Speed

Some repeaters may not respond correctly if a DTMF code is transmitted at fast speed. If this happens, change the DTMF code transmission speed from FAST (default) to SLOW.

- 1 Enter Menu mode and access Menu 302.



- 2 Set the speed to FAST or SLOW.

■ Selecting a Pause Duration

You can change the pause duration stored in DTMF Memory channels; the default is 500 msec.

- 1 Enter Menu mode and access Menu 303.

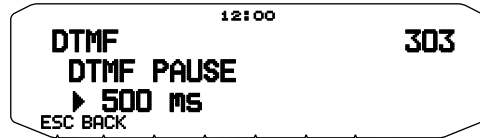

- 2 Select a speed (in msec) from the available list: 100/ 250/ 500/ 750/ 1000/ 1500/ 2000.

DTMF KEY LOCK

This function will lock the DTMF transmission keys so that they will not transmit if they are accidentally pressed. To lock the DTMF keys, turn this function ON.

- 1 Enter Menu mode and access Menu 304.

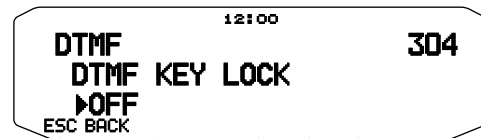

- 2 Set the key lock to ON or OFF.

WHAT IS EchoLink?

EchoLink allows you to communicate with other amateur radio stations over the internet, using VoIP (voice-over-IP) technology. The EchoLink software program allows worldwide connections to be made between stations, or from computer to station, greatly enhancing your communications capabilities.

To use EchoLink, you must register using your callsign on their website and download the EchoLink software program (free of charge). Refer to the website for PC hardware and other requirements.

Official EchoLink Website: <http://www.echolink.org>

Note: EchoLink is a registered trademark of Synergenics, LLC.

STORING EchoLink MEMORY

There are 10 dedicated EchoLink DTMF Memory channels available. You can store up to 8 digits in each channel.

- 1 Enter Menu mode and access Menu 204.



- 2 Rotate the **Tuning** control to select an EchoLink channel number from EL0 ~ EL9.
- 3 Press the **Tuning** control to set the selected channel number.
 - The name entry display appears.



- 4 Enter the name for the channel, then press the **Tuning** control to set it.
 - The callsign and conference name (for board rooms that can do round QSO) of the other station which is connected via EchoLink, or the control command name, etc., are entered into the EchoLink memory name.
 - The code entry display appears.



- 5 Enter a DTMF code for the channel, then press the **Tuning** control to set it.
 - The node number of the other station and conference which are connected via EchoLink, or the DTMF code of the control command, etc., are entered into the EchoLink code.

Transmitting EchoLink Memory

- 1 Press and hold the microphone [PTT].
- 2 While transmitting, press the **Tuning** control.
 - The last called EchoLink DTMF Memory channel name and number appears on the display.

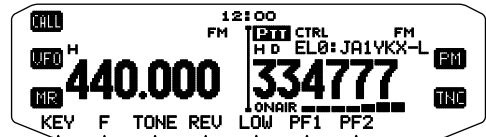

- 3 While still transmitting, rotate the **Tuning** control to select your desired EchoLink Memory channel, then press the **Tuning** control to set the channel.
 - The stored code scrolls across the display and is transmitted.

Note:

- ◆ In step 2, press the microphone [C] key before pressing the **Tuning** control, to transmit the converted DTMF code of the EchoLink "Connect by Call" function. (example: JA1YKX)
"C" "51 21 10 93 52 92 #" (# is automatically added to the end of the DTMF code)
- ◆ In step 2, press the microphone [0] [7] keys before pressing the **Tuning** control, to transmit the converted DTMF code of the EchoLink "Query by Call" function. (example: JA1YKX)
"0" "7" "51 21 10 93 52 92 #" (# is automatically added to the end of the DTMF code)
- ◆ When only the EchoLink memory name has been registered, the EchoLink "Connect Call" function transmits the converted DTMF code. (example: JA1YKX)
"C 51 21 10 93 52 92 #" (C is automatically added to the beginning of the DTMF code and # is automatically added to the end)

Call sign/ DTMF Code Conversion Table

When a character other than an alphanumeric character is used (such as "-" and "/"), the DTMF conversion stops at the character before that non-standard character.

	1	2	3	4	5	6	7	8	9	0
0	1	2	3	4	5	6	7	8	9	0
1	Q	A	D	G	J	M	P	T	W	
2	Z	B	E	H	K	N	R	U	X	
3		C	F	I	L	O	S	V	Y	

■ Selecting a Transmit Speed

Some repeaters may not respond correctly if a code is transmitted at fast speed. If this happens, change the EchoLink transmission speed from FAST (default) to SLOW.

- 1 Enter Menu mode and access Menu 205.



- 2 Set the speed to FAST or SLOW.

- To turn EchoLink Sysop Mode OFF, press **[PF2] + Power ON** again.

EchoLink Sysop Mode ON		
PC terminal		PC
TxD	→	RxD
RxD	←	TxD
SQC	→	CTS
PKS	←	RTS
GND	↔	GND

EchoLink Sysop Mode OFF		
PC terminal		PC
TxD	→	RxD
RxD	←	TxD
RTS	→	CTS
CTS	←	RTS
GND	↔	GND

SETTING UP EchoLink Sysop MODE

Connect the TM-D710 to a personal computer to use the system as a node station for EchoLink relaying.

When connecting to a personal computer and using the EchoLink Sysop mode, the hard flow control operation RTS and CTS computer terminals operate the same as and are changed with the SQC (squellch control signal output to the computer) and PKS (transmit control signal input from the computer) data terminals.

The current band becomes the same as the data band which is selected in menu No. 517, regardless of the transmission band and operation band.

Use the PG-5H (interface cable kit) when connecting to a personal computer.

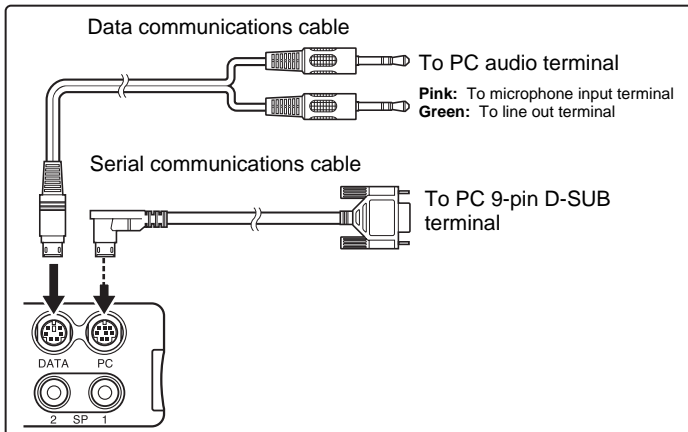

- 1 Turn the transceiver power OFF.
- 2 Press **[PF2] + Power ON** to turn EchoLink Sysop Mode ON.
 - The **ET** icon appears on the display when EchoLink Sysop mode is ON.
 - When the audio signal is output to the PC side, the **ET** icon blinks.

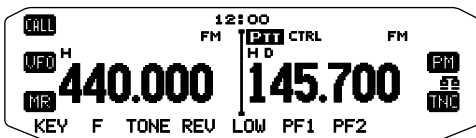

OTHER OPERATIONS

POWER ON MESSAGE

Each time you switch the transceiver ON, "HELLO" (default) appears on the display for approximately 2 seconds. You can program your favorite message in place of the default message.

- 1 Enter Menu mode and access Menu 500.

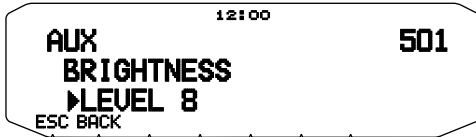

- 2 Enter your desired message.
 - Press [CLR] to clear the entire message, if necessary.

DISPLAY ILLUMINATION

You can manually change the display illumination to suit the lighting conditions where you are operating.

- 1 Enter Menu mode and access Menu 501.

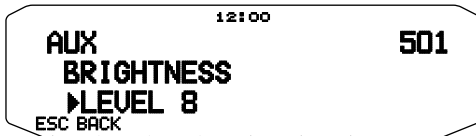

- 2 Set your desired brightness level from 1 to 8, or OFF.

Auto Display Brightness

When Auto Brightness is activated, the display will light up every time a key is pressed.

- 1 Enter Menu mode and access Menu 502.



- 2 Set the Auto Brightness function to ON or OFF.

Backlight Color

You can manually change the display illumination to suit the lighting conditions where you are operating.

- 1 Enter Menu mode and access Menu 503.



- 2 Set the backlight color to AMBER or GREEN.

Display Contrast

The display visibility changes depending on the ambient conditions, for example between daytime and night. When you find the display is not clear, use this function to select the optimum display contrast.

- 1 Enter Menu mode and access Menu 504.

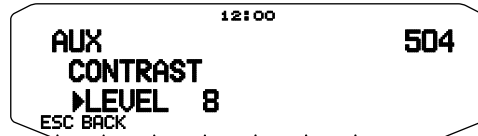

- 2 Set your desired contrast level from 1 to 16.

Note: The display contrast may be affected by a change in temperature. Adjust the contrast as necessary.

Positive/ Negative Reversal

You can change the display status between Negative and Positive (default).

- 1 Enter Menu mode and access Menu 505.



- 2 Set the backlight color to NEGATIVE or POSITIVE.

KEY LOCK

The Key Lock function ensures that your transceiver settings will remain unchanged if you accidentally press a key. When activated, the following functions can still be used:

- [PWR]
- [PTT]

To turn Key Lock ON or OFF, press [F] (1s).

- When Key Lock is activated, the **LOCK** icon will appear on the display.

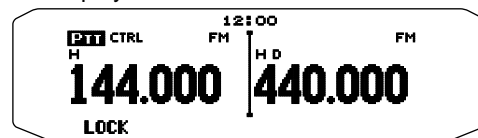

Microphone Key Lock

The Microphone Key Lock function will lock the microphone PF (Programmable Function) keys.

- 1 Enter Menu mode and access Menu 513.

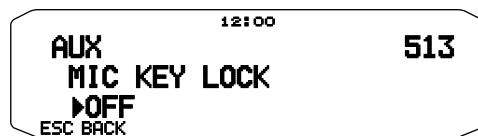

- 2 Turn the Microphone Key Lock function ON or OFF.

KEY BEEP

You can turn the transceiver beep function ON or OFF as desired.

- 1 Enter Menu mode and access Menu 000.



- 2 Turn the beep function ON or OFF.

- Even with the beep function turned OFF, the transceiver will emit a beep tone under the following conditions:
 - 1) When Auto Power Off is activated, the transceiver will beep 1 minute before the power turns off.
 - 2) After transmitting for the maximum time duration according to the Time-out Timer, the transceiver will beep

Beep Volume

Each time you press a key, the beep tone will sound. If you have left the beep function turned ON, you may wish to adjust the volume level of the beep.

- 1 Enter Menu mode and access Menu 001.



- 2 Set the beep volume to a level from 1 to 7.

- The default is level 5.

EXTERNAL SPEAKER CONFIGURATION

This transceiver has two speaker jacks for external speakers, as well as an internal speaker. You can enjoy a variety of speaker configurations by using one or two external speakers. Received signals on bands A and B are output depending on how you want the internal and/or external speakers to function.

- 1 Enter Menu mode and access Menu 002.



- 2 Set the speaker mode to MODE 1 or MODE 2.

- Refer to the table below for configurations based on the mode selected.

Mode	Speaker Setup	Band Output		
		Internal Speaker	External SP1	External SP2
MODE 1	None	A, B	–	–
	SP1 only	x	A, B	–
	SP2 only	A	–	B
	SP1, SP2	x	A	B
MODE 2	None	A, B	–	–
	SP1 only	x	A, B	–
	SP2 only	B	–	A
	SP1, SP2	x	B	A

PROGRAMMABLE VFO

If you always check frequencies within a certain range, you can set upper and lower limits for frequencies that are selectable. For example, if you select 144 MHz for the lower limit and 145 MHz for the upper limit, the tunable range will be from 144.000 MHz to 145.995 MHz.

- 1 Select your desired VFO frequency.
- 2 Enter Menu mode and access Menu 100.

(Example: E type)

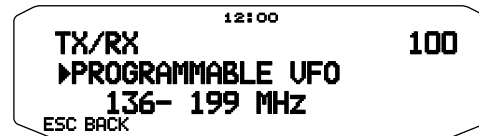

- 3 Press the **Tuning** control.

- The lower frequency limit blinks.

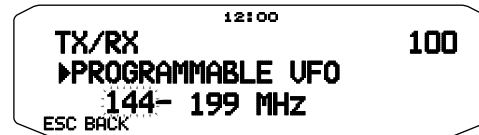

- 4 Rotate the **Tuning** control to select your desired lower frequency limit, then press the **Tuning** control to set the selected value.

- The upper frequency limit blinks.



- 5 Rotate the **Tuning** control to select your desired upper frequency limit, then press the **Tuning** control to set the selected value.

- 6 Press **[ESC]** to exit Menu mode.

Note: You cannot program the 100 kHz and subsequent digits. The exact 100 kHz and subsequent digits of the upper limit depend on the frequency step size you are using.

CHANGING THE FREQUENCY STEP SIZE

Choosing the correct frequency step size is essential in selecting your exact frequency. The default step size on the 144 MHz band is 5 kHz (K type) or 12.5 kHz (E, M4 types). The default on the 430/440 MHz band is 25 kHz (K, E types) or 10 kHz (M4 type).

- 1 Press the left or right **[BAND SEL]** to select band A or B, then press **[VFO]**.
- 2 Enter Menu mode and access Menu 101.

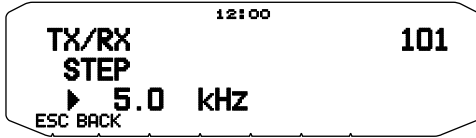

- 3 Set the step size to 5.0*, 6.25*, or 8.33 kHz (118 MHz band only) or to 10.0, 12.5, 15.0*, 20.0, 25.0, 30.0, 50.0, or 100.0 kHz.

* These step sizes are not available for the 1200 MHz band.

Note: Changing between step sizes may correct the displayed frequency. For example, if 144.995 MHz is displayed with a 5 kHz step size selected, changing to a 12.5 kHz step size corrects the displayed frequency to 144.9875 MHz.

PROGRAMMABLE FUNCTION KEYS

■ Transceiver Front Panel

There are 2 PF (Programmable Function) keys on the transceiver front panel: PF1 and PF2. You can assign your own desired functions to these 2 keys.

- 1 Enter Menu mode and access Menu 507 (PF1) and/or Menu 508 (PF2).



- 2 Set your desired function for the key. Programmable functions available are: WX CH (Weather Channel)/ FRQ.BAND (Frequency bands)/ CTRL (Control)/ MONITOR (Monitor)/ VGS (Voice recorder)/ VOICE (Voice announcement)/ GROUP UP (Memory group up)/ MENU (Menu mode)/ MUTE (Speaker Mute)/ SHIFT (Shift)/ DUAL (Dual Mode)/ M>V (Memory to VFO Copy)/ 1750 (1750 Hz Tone)/ .

■ Microphone Keys

There are 4 microphone PF (Programmable Function) keys: [PF] (PF1), [MR] (PF2), [VFO] (PF3) and [CALL] (PF4). You can assign your own desired functions to these 4 keys.

- 1 Enter Menu mode and access Menu 509 (MIC. PF1) and/or Menu 510 (MIC. PF2) and/or Menu 511 (MIC. PF3) and/or Menu 512 (MIC. PF4).

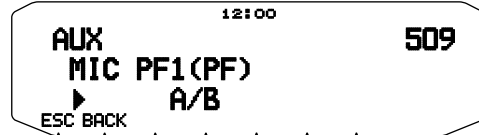

- 2 Set your desired function for the key. Programmable functions available are: WX CH (Weather Channel)/ FRQ.BAND (Frequency bands)/ CTRL (Control)/ MONITOR (Monitor)/ VGS (Voice recorder)/ VOICE (Voice announcement)/ GROUP UP (Memory group up)/ MENU (Menu mode)/ MUTE (Speaker Mute)/ SHIFT (Shift)/ DUAL (Dual Mode)/ M>V (Memory to VFO Copy)/ VFO/ MR/ CALL/ MHz/ TONE/ REV (Reverse)/ LOW/ LOCK/ A/B (Band Select A/ Band Select B)/ ENTER/ 1750 (1750 Hz Tone)/ M.LIST (Message list)/ S.LIST (Station list)/ MSG.NEW/ REPLY/ POS/ P.MONI/ BEACON/ DX/ WXi.

FREQUENCY DIRECT ENTRY

If the desired operating frequency is far from the current frequency, using the microphone keypad is the quickest way to change the frequency. One of the microphone PF keys must first be programmed as **[ENTER]**,

- 1 Press the left or right **[BAND SEL]** to select band A or B, then press **[VFO]** or **[CALL]**.
- 2 Press the key programmed as **[ENTER]**.
 - The Direct Frequency Entry display appears.

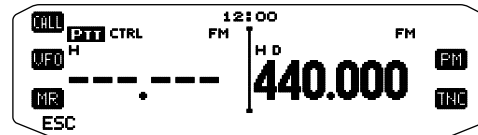

- 3 Press the microphone keys (**[0]** ~ **[9]**) to enter your desired frequency.
- 4 To set the entered frequency, press **[ENTER]** or **[VFO]**.
 - Pressing **[ENTER]** before entering all of the digits will set the remaining digits to 0.
 - Pressing **[VFO]** before entering all of the digits will leave the remaining digits at their previous values.
 - Entering all digits for a frequency will automatically set the frequency without pressing **[ENTER]** or **[VFO]**.
 - If you need to only change the MHz digit, press the **Tuning** control, then enter the new value.

AUTOMATIC POWER OFF (APO)

Automatic Power Off is a background function that monitors whether or not any operations have been performed (keys pressed, **Tuning** control turned, etc.), and turns the transceiver power OFF if it has not been in use.

- 1 Enter Menu mode and access Menu 516 (APO).



- 2 Set the APO time limit to 30, 60, 90, 120, 180 minutes, or OFF.

- After the time limit passes with no operations (default is OFF), APO turns the transceiver power OFF. However, 1 minute before the power turns OFF, "APO" appears on the display and blinks, and a warning tone sounds.

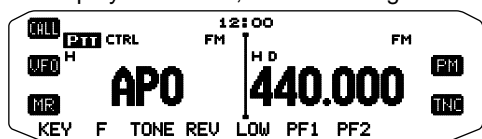

Note: If any settings are changed during while APO is ON, the timer resets. When you stop changing the settings, the timer begins counting again from 0.

SWITCHING FM/AM MODE

This transceiver is also capable of receiving (not transmitting) in AM on band A. The default mode on the 118 MHz band is AM while the default on the 144, 220, 300, or 430/440 MHz band is FM.

- 1 Enter Menu mode and access Menu 102.

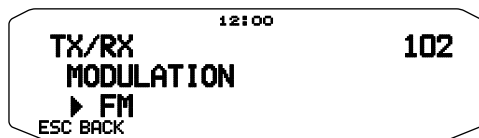

- 2 Set the mode to AM, FM, or NFM.

Note: You cannot switch between FM and AM to receive on band B.

ADVANCED INTERCEPT POINT (AIP)

The VHF/UHF band is often crowded in urban areas. AIP helps eliminate interference and reduce audio distortion caused by inter modulation. You can use this function only while operating on the VHF/UHF band.

- 1 Enter Menu mode and access Menu 103 (VHF.AIP) and/or Menu 104 (UHF.AIP).

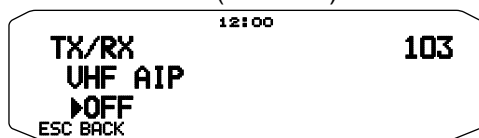

- 2 Set the AIP to ON or OFF.

S-METER SQUELCH

S-meter Squelch causes the squelch to open only when a signal with the same or greater strength than the S-meter setting is received. This function relieves you from constantly resetting the squelch when receiving weak stations that you have no interest in.

- 1 Enter Menu mode and access Menu 105.

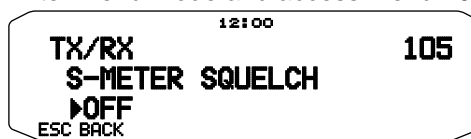

- 2 Set the S-Meter squelch to ON or OFF.

- 3 To select the desired S-meter setting, rotate the left (band A) or right (band B) SQL control depending on which band you have selected.

- The squelch will open only at the level you have selected (for example, level 9).

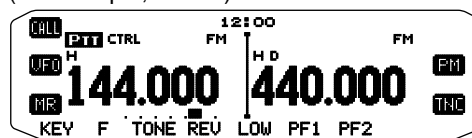

■ Squelch Hang-up Time

When using S-meter Squelch, you may want to adjust the time interval between when the received signals drop and when the squelch closes.

- 1 Enter Menu mode and access Menu 106.



- 2 Set the hang-up time to 125, 250 or 500 ms, or OFF.

SPEAKER MUTE

While receiving or transmitting on the TX band, you may not want to hear audio received on the other band. Use this function to mute the speaker allocated to that band (not the TX band).

While receiving, press **[F]**, **[MUTE]** to switch the mute function ON or OFF.

- The **MUTE** icon appears on the display when the function is ON.

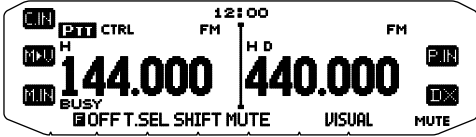

■ Mute Hang-up Time

When using Speaker Mute, you may want to adjust the time interval between when you receive a signal and when the speaker is muted.

- 1 Enter Menu mode and access Menu 107.



- 2 Set the hang-up time to 125, 250, 500, 750, or 1000 ms.

BEAT SHIFT

Since the transceiver uses a microprocessor to control various transceiver functions, the CPU clock oscillator's harmonics or image may appear on some spots of the reception frequencies. In this case, we recommend you turn the Beat Shift function ON.

- 1 Enter Menu mode and access Menu 108.



- 2 Set the Beat Shift to ON or OFF.

SELECTING AN OUTPUT POWER

It is a good idea to select lower transmit power if communications is still reliable. This lowers the risk of interfering with others on the band. When operating from battery power, you will enjoy more operating time before a recharge is necessary.

Press **[LOW]** to select high (H) (K, E types only), medium (M), or low (L) power.

- You can program different power settings for bands A and B.

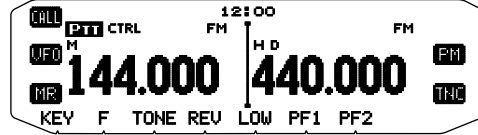

Note: When the transceiver overheats because of ambient high temperature or continuous transmission, the protective circuit may function to lower transmit output power.

TIME-OUT TIMER (TOT)

It is sometimes necessary or desirable to restrict a single transmission to a specific maximum time. You may use this function to prevent repeater time-outs when accessing repeaters, or to conserve battery power.

When TOT times out (default is 10 minutes), the transceiver generates beeps and automatically returns to receive mode. To resume transmitting, release and then press the microphone **[PTT]** again.

- 1 Enter Menu mode and access Menu 109.

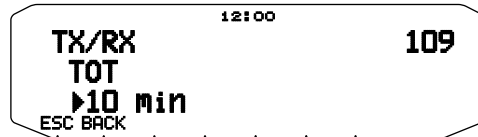

- 2 Set the timer to 3, 5, or 10 minutes.

MICROPHONE SENSITIVITY

The input level to the microphone can be configured.

- 1 Enter Menu mode and access Menu 111.



- 2 Set the Microphone Sensitivity to HIGH, MEDIUM or LOW.

Note: The higher the input level to the microphone is configured, the easier to gain the surrounded sounds.

MASKING A BAND

If you have no plans to use band A or B, you can hide the frequency display on the unused band. This saves power consumption and makes it simpler to read the information you need.

- 1 Turn the transceiver power OFF.
- 2 Press the left or right **[BAND SEL] + Power ON**.
 - The band mask display appears.



- 3 Rotate the **Tuning** control to select the band you want to hide (or return to normal).
- 4 Press the **Tuning** control to set the selected band.
- 5 Rotate the **Tuning** control to set the band to select USE or MASK.
 - USE allows you to see and use the band as normal. MASK hides the band on the display.



- 6 Press the **Tuning** control to set the selection.
- 7 Press the **[ESC]** to exit.

Note: You cannot operate the masked band nor use it to receive or transmit.

DISPLAY PARTITION BAR

The partition bar that appears between bands A and B can be removed if desired.

- 1 Enter Menu mode and access Menu 527.



- 2 Set the partition bar display to ON or OFF.

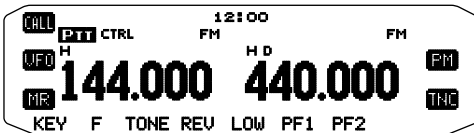
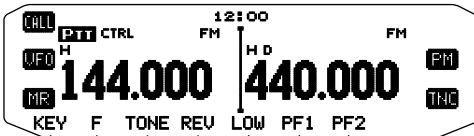

POWER ON PASSWORD

If power on password is activated, you cannot operate the transceiver without first entering your password, after turning the transceiver power ON. Your password can be changed using the MCP-2A software, and can contain up to 6 digits.

- 1 Enter Menu mode and access Menu 998.

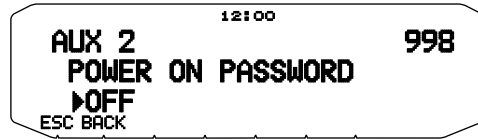

- 2 Set the power on password to ON or OFF.
 - When set to ON, "PASSWD" appears on the display.

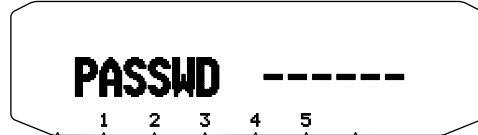

- 3 Enter your password.

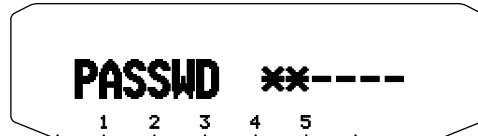

- 4 After entering up to 6 digits, press the **Tuning** control to set the password.

Note: Even with Menu 998 turned ON, the power on password function will not be activated unless you first program a password using the MCP-2A software.

PACKET OPERATION

Connect this transceiver to your personal computer via a Terminal Node Controller (TNC). You can send messages or commands to far away stations, obtain a variety of information via your local bulletin boards, or enjoy other Packet applications. Reference material for starting Packet operation should be available at any store that handles Amateur Radio equipment.

Note: When the distance between the radio antenna and your personal computer is too close, interference may occur.

DATA terminal pins

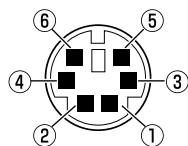

- When using the built-in TNC, the DATA terminal is not used.

No.	Name	I/O	Function
①	PKD	I	Audio signal for packet transmission
②	DE	—	PKD terminal ground
③	PKS	I	'L' is transmitted and the microphone is muted
④	PR9	O	Detected 9600 (bps) data
⑤	PR1	O	Detected 1200 (bps) data
⑥	SQC	O	Squelch control signal; Closed: 'L', Open: 'H' (The default settings can be changed in Menu 520)

COM terminal pins

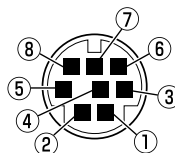

- The COM terminal is on the rear of the Operation panel. Connect this terminal to a personal computer; do not connect a computer to the PC terminal of the TX/RX unit.

No.	Name	I/O	Function
①	RTS	O	Request to Send
②	CTS	I	Clear to Send
③	TXD	O	Transmit Data
④	GND	—	Ground
⑤	RXD	I	Receive Data
⑥	NC	—	Non Connect
⑦	NC	—	Non Connect
⑧	NC	—	Non Connect

PACKET MODE

This transceiver has a built-in TNC which conforms to the AX.25 protocol. This protocol is used for communications between TNCs.

For the commands supported by the built-in TNC, see "TNC COMMANDS LIST".

Press [TNC] 2 times to enter PACKET mode.

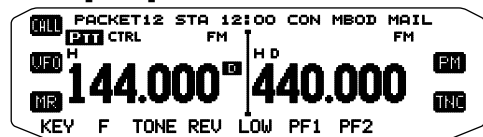

The following indicators appear on the transceiver display to show the current TNC status:

Indicator	Status
PACKET	The TNC is in Packet mode.
STA	Packets to be transmitted still remain in the buffer.
CON	The TNC is in connection with the target station.
MBOD	The mailbox in the TNC is being accessed or connected by the other station.
MAIL	The mailbox in the TNC holds mail addressed to you.
12	1200 bps packet transfer rate selected.
96	9600 bps packet transfer rate selected.

Note:

- Not all functions available via conventional TNC's are supported by the TNC built in this transceiver.
- The built-in TNC could be automatically reinitiated when its malfunction is detected; this does not designate that the transceiver is defective.
- To distinguish your various stations or nodes, you can have up to 15 Secondary Station Identifiers (SSIDs); ex. W6DJY-1 to W6DJY-15. You always have to put a dash between your callsign and SSID number.
- Packet operation, easily affected by transmit and receive conditions, requires a full-scale S-meter reading for reliable communication. When the S-meter reads less than maximum during 9600 bps operation, communication errors are frequent.

DATA BAND

Select how data will be transmitted and received on your transceiver.

- 1 Enter Menu mode and access Menu 529.



- 2 Set the data band to A-BAND (A band receives and transmits), B-BAND (B band receives and transmits), TX:A-BAND RX:B-BAND (A band transmits (T:0) and B band receives (R:0)), or RX:A-BAND TX:B-BAND (A band receives (R:0) and B band transmits (T:0)).

COM PORT SPEED

You can adjust the speed at which the computer and transceiver exchange information, when the transceiver is connected to your computer.

- 1 Enter Menu mode and access Menu 528.



- 2 Set the COM port speed to 9600, 19200, 38400, or 57600 bps.
 - Turning the power ON/OFF will change the port speed setting.

USING EXTERNAL TNC

External Data Band

- 1 Enter Menu mode and access Menu 517.



- 2 Set the data band to A-BAND (A band receives and transmits), B-BAND (B band receives and transmits), TX:A-BAND RX:B-BAND (A band transmits and B band receives), or RX:A-BAND TX:B-BAND (A band receives and B band transmits).

DATA Terminal Speed

Select 1200 or 9600 bps for the data transfer rate, depending on TNC.

1200 bps: Transmit data input (PKD) sensitivity is 40 mV_{p-p}, and input impedance is 10 kΩ.

9600 bps: Transmit data input (PKD) sensitivity is 2 V_{p-p}, and input impedance is 10 kΩ.

- 1 Enter Menu mode and access Menu 518.



- 2 Set the data speed to 1200 or 9600 bps.

PC Port Speed

- 1 Enter Menu mode and access Menu 519.



- 2 Set the PC port speed to 9600, 19200, 38400, or 57600 bps.
 - Turning the power ON/OFF will change the port speed setting.

SQC Output Setting

You can set the condition for which the SQC output terminal becomes active.

- 1 Enter Menu mode and access Menu 520.

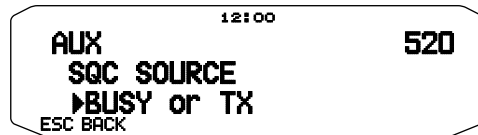

- 2 Set the SQC output activation method to one of the following:
 - OFF: SQC output remains inactive.
 - BUSY: When a signal is received on the data band, the SQC output becomes active.
 - SQL: While CTCSS/DCS is ON and a matching signal is received, the SQC output becomes active. While CTCSS/DCS is OFF, the SQC output becomes active when a busy signal is received.
 - TX: While transmitting, the SQC output becomes active.
 - BUSY.TX: When the conditions of BUSY and TX (above) are met, the SQC output becomes active.
 - SQL.TX: When the conditions of SQL and TX (above) are met, the SQC output becomes active.

Note: The activation type (logic) can be changed using the MCP-2A software ([Edit] - [Data Terminal] - [SQC Output Logic]).

TNC COMMANDS LIST

The commands supported by the built-in TNC are listed below. You must enter a space between a command name (or short-form) and a parameter, or between two parameters; ex. AU OFF, BEACON EVERY 18.

Command Name	Short	Description	Parameter	Default
8BITCONV	8	When ON, handles one character using 8 bits in Converse mode. When OFF, handles one character using 7 bits.	ON/ OFF	ON
AFILTER	AF	Specifies up to 4 control codes to be removed from received packets when in Converse mode.	\$00 ~ \$80	\$00
AUTOLF	AU	When ON, sends a line feed (LF) to the computer after each carriage return (CR).	ON/ OFF	ON
AXDELAY	AXD	Specifies the delay time to be added to TXDELAY between PTT ON and start of transmission. The unit of the parameter is 10 milliseconds.	0 ~ 120	0
AXHANG	AXH	Specifies the voice repeater hang time. The unit of the parameter is 100 milliseconds.	0 ~ 250	0
BEACON	B	If set to EVERY, sends a beacon packet at intervals of the specified period (n). If set to AFTER, sends a beacon packet only once after the specified period (n). The unit of n is 10 seconds.	EVERY/ AFTER n (n = 0 ~ 250)	EVERY 0
BTEXT	BT	Specifies the content of the data portion of a beacon packet.	0 ~ 159 characters	-
CALIBRAT	CAL	Sends a space/mark square wave (50/50 ratio). Enter Q to exit Calibrate mode and restore the Command mode.	-	-
CHECK	CH	Specifies the interval from signal drop-out until execution of disconnection. The unit of the parameter is 10 seconds.	0 ~ 250	30
CONMODE	CONM	With NOMODE set to OFF, causes the TNC to automatically enter Converse or Transparent mode when connection is completed.	C/ T	C
CONNECT	C	Sends a connect request. Call1 is the callsign of the station to be connected to. Call2 to call9 are callsigns of stations to be digipeated through.	Call1 (VIA call2, call3, ... call9)	-
CONOK	CONO	When ON, accepts a connect request and returns a UA packet. When OFF, rejects a connect request and returns a DM packet.	ON/ OFF	ON
CONSTAMP	CONS	When ON, displays the current date and time when connection is completed. The correct date and time must be set using DAYTIME.	ON/ OFF	OFF
CONVERSE	CONV or K	Causes the TNC to enter Converse mode. Press [Ctrl]+[C] to restore the Command mode.	-	-
CPACTIME	CP	When ON and in Converse mode, sends a packet at intervals of the period determined by PACTIME.	ON/ OFF	OFF
CR	CR	When ON, appends a carriage return (CR) to all packets to be sent.	ON/ OFF	ON
DAYSTAMP	DAYS	When ON, pressing [Ctrl]+[T] in Converse mode causes the TNC to send date data in addition to time data.	ON/ OFF	OFF
DAYTIME	DA	Sets the current date and time. Enter YYMMDDhhmmss. Sets 00 as the second if entry of the second is omitted.	-	-
DAYUSA	DAYU	When ON, displays the date like MM/DD/YY. When OFF, displays the date like DD-MM-YY.	ON/ OFF	ON
DIGPEAT	DIG	When ON, allows the TNC to function as a digipeater.	ON/ OFF	ON
DISCONNE	D	Sends a disconnect request.	-	-

Command Name	Short	Description	Parameter	Default
DISPLAY	DISP	Causes the TNC to display the current status of all the commands. You can also specify a class identifier A, C, H, I, L, M, or T to display the status of only the desired command class. Enter a space between the command name and a class identifier; ex. DISPLAY H. A (ASYNC): RS-232C port parameters C (CHAR): Special TNC characters H (HEALTH): Counter parameters I (ID): ID parameters L (LINK): TNC-to-TNC link status M (MONITOR): Monitor parameters T (TIMING): Timing parameters	-	-
DWAIT	DW	Specifies the interval from no carrier detection until execution of transmission. The unit of the parameter is 10 milliseconds.	0 ~ 250	30
ECHO	E	When ON, causes the TNC to echo received characters to the computer.	ON/ OFF	ON
EPATH	EPATH	Specifies digipeater callsigns to be added when the UISSID parameter in a received packet is 10 or 14.	Call1, ... call7	-
EXTCLR	EXTC	Clears the contents of the TNC mailbox.	-	-
FILE	FI	Displays the list of all messages in the TNC mailbox.	-	-
FIRMRNR	FIR	The other station sends a notice (packet) to you if it is not ready to receive data. When ON, receiving such a notice causes the TNC to suspend transmission until it receives a "ready" notice.	ON/ OFF	OFF
FLOVER	FL	Specifies the time delay from when the TNC buffer becomes full until the TNC buffer is cleared. The unit of the parameter is 1 minute.	0 ~ 120	0
FLOW	F	When ON, starting key entry causes the computer to stop displaying received packets.	ON/ OFF	ON
FRACK	FR	Specifies the interval from one transmission until retry of transmission. The unit of the parameter is 1 second.	0 ~ 15	3
FULLDUP	FU	When ON, allows the TNC to function in full duplex. When OFF, allows it to use data carrier detect signals to avoid packet collision.	ON/ OFF	OFF
GBAUD	GB	Selects 4800 or 9600 bps as the transfer rate between the TNC and the GPS receiver.	2400/ 4800/ 9600	4800
GPSEND	GPSS	Specifies the content of data to be output to the GPS receiver; this data is used to program the default settings on the receiver. The output data is not stored in memory.	0 ~ 159 characters	-
GPSTEXT	GPST	Specifies the type of a message to be determined by LTEXT.	0 ~ 6 characters	\$PNTS
HBAUD	HB	Selects 1200 or 9600 bps as the transfer rate between packet stations.	1200/ 9600	1200
HEALLED	HEAL	Determines whether or not normal operations of the ROM are checked. When ON and if normal operations are detected, "STA" and "CON" appear and blink alternately.	ON/ OFF	OFF
HID	HI	When ON, causes the TNC to send an ID packet every 9.5 minutes after digipeating.	ON/ OFF	ON
ID	I	Causes the TNC to send an ID packet.	-	-
KILL	KI	Deletes specific messages in the TNC mailbox.	-	-

Command Name	Short	Description	Parameter	Default
KISS	KISS	When ON, entering a RESTART command causes the TNC to enter (or exit) KISS mode.	ON/ OFF	OFF
LCSTREAM	LCS	When ON, changes a small letter (a through z) entered as a stream designator, to a capital letter (A through Z). A stream designator must be entered immediately after STREAMSW.	ON/ OFF	ON
LIST	LI	Displays the list of messages, in the TNC mailbox, other than those addressed to other stations.	-	-
LOCATION	LOC	If set to EVERY, sends GPS data at intervals of the specified period (n). If set to AFTER, sends GPS data only once after the specified period (n). The unit of n is 10 seconds.	EVERY/ AFTER n (n = 0 ~ 250)	EVERY 0
LOG	LOG	Displays the list of stations which have connected to the TNC mailbox.	-	-
LPATH	LPA	Specifies callsigns to send GPS data. Call1 is the callsign of the destination. Call2 to call9 are callsigns of stations to be digipeated through.	Call1 (VIA call2, call3, ... call9)	GPS
LTEXT	LT	Specifies the content of a message to be included in GPS data.	0 ~ 159 characters	-
LTMON	LTM	Specifies the interval for displaying a message determined by LTEXT on the screen; a message appears like a received beacon packet. The unit of the parameter is 1 second.	0 ~ 250	0
MAIL	MAI	When ON and the TNC mailbox holds a message addressed to you, outputs "Low" to the MAILED terminal.	ON/ OFF	OFF
MAXFRAME	MAX	Specifies the maximum number of packets to be transmitted at one time.	1 ~ 7	4
MBOD	MB	When ON, allows the TNC mailbox to be used.	ON/ OFF	OFF
MCOM	MCOM	When ON, causes the TNC to also monitor control packets. When OFF, causes it to monitor only information packets.	ON/ OFF	OFF
MCON	MC	When ON, causes the TNC to monitor other stations while in connection with the target station.	ON/ OFF	OFF
MINE	MI	Displays the list of messages, in the TNC mailbox, addressed to you and messages that you sent.	-	-
MONITOR	M	When ON, causes the TNC to monitor packets.	ON/ OFF	ON
MRPT	MR	When ON, causes the TNC to display the entire digipeat list for monitored packets.	ON/ OFF	ON
MSTAMP	MS	When ON, causes the TNC to display data and time information for monitored packets.	ON/ OFF	OFF
MYALIAS	MYA	Specifies a callsign for using your station as a digipeater.	6 characters + SSID	-
MYCALL	MY	Specifies your callsign.	6 characters + SSID	-
MYMCALL	MYM	Specifies a callsign to be assigned to your TNC mailbox.	6 characters + SSID	-
NEWMODE	NE	When ON, entering a CONNECT command causes the TNC to immediately enter the other mode.	ON/ OFF	OFF
NOMODE	NO	When ON, does not cause the TNC to automatically enter the other mode. When OFF, causes it to automatically enter the other mode as specified by NEWMODE.	ON/ OFF	OFF

Command Name	Short	Description	Parameter	Default
NPATH	NPATH	Specifies digipeater callsigns to be added when the UISSID parameter in a received packet is 8 or 12.	Call1, ... call7	–
NTSGRP	NTSGRP	Specifies a group code to be used for making a \$PNTS sentence.	0 ~ 3 characters	–
NTSMRK	NTSMRK	Specifies a mark number to be used for making a \$PNTS sentence.	\$00 ~ \$14	\$00
NTSMMSG	NTSMMSG	Specifies a message to be used for making a \$PNTS sentence.	0 ~ 20 characters	–
OVERKILL	OVE	Specifies the number of old messages to be deleted when the TNC mailbox does not accept a new message because the memory is full.	0 ~ 255	0
PACLEN	P	Specifies the maximum length of the data portion of a packet.	0 ~ 255	128
PACTIME	PACT	If set to EVERY, sends a packet at intervals of the specified period (n). If set to AFTER, sends a packet only once after the specified period (n). The unit of n is 100 milliseconds.	EVERY/ AFTER n (n = 0 ~ 250)	AFTER 10
PERSIST	PE	Specifies a parameter to calculate probability for the PERSIST/SLOTTIME method.	0 ~ 255	128
PPERSIST	PP	Causes the TNC to use the PERSIST/SLOTTIME method when ON, or the DWAIT method when OFF.	ON/ OFF	ON
RAMTEST	RAMTEST	Checks the RAM after clearing it.	–	–
READ	R	Specifies one or more message numbers to be read from the TNC mailbox.	–	–
RESET	RESET	Restores the default status for all the commands.	–	–
RESPTIME	RES	Specifies the acknowledgment packet transmission delay. The unit of the parameter is 100 milliseconds.	0 ~ 250	5
RESTART	RESTART	Causes the TNC to function as if it is switched OFF then ON.	–	–
RETRY	RE	Specifies the number of transmission retries.	0 ~ 15	10
ROUTE	ROU	When ON and receiving a packet forwarded by a PBBS, leaves the included route information.	ON/ OFF	ON
SENDPAC	SE	Specifies a character which forces a packet to be sent.	0 ~ \$7F	\$0D
SLOTTIME	SL	Specifies the period of random number generation intervals for the PERSIST/SLOTTIME method. The unit of the parameter is 10 milliseconds.	0 ~ 250	3
SPATH	SPATH	Specifies digipeater callsigns to be added when the UISSID parameter in a received packet is 9 or 13.	Call1, ... call7	–
STREAMCA	STREAMC	When ON and multiple connections take place, receiving a packet causes the TNC to display the callsign.	ON/ OFF	ON
STREAMDB	STREAMD	When ON, causes the TNC to display a stream switch character included in a received packet.	ON/ OFF	OFF
STREAMSW	STR	Specifies a character to be used for switching streams.	0 ~ \$7F	\$01
TOUT	TOUT	Specifies the time-out time of the TNC mailbox. When no packet is received within the specified time, a disconnect takes place. The unit of the parameter is 10 seconds.	0 ~ 250	30
TRACE	TRAC	When ON, causes the TNC to display all received packets in their entirety.	ON/ OFF	OFF
TRANS	T	Causes the TNC to exit Command mode and enter Transparent mode. To restore Command mode, press and hold [Ctrl], then press [C] three times.	–	–

Command Name	Short	Description	Parameter	Default
TRFLOW	TRF	When ON, causes the TNC to respond to software flow control from the computer in Transparent mode.	ON/ OFF	OFF
TRIES	TRI	Specifies the number of transmission retries programmed in the retry counter.	0 ~ 15	0
TXDELAY	TX	Specifies the time delay between PTT ON and start of transmission. The unit of the parameter is 10 milliseconds.	0 ~ 120	50
TXFLOW	TXF	When ON, allows the TNC to send a software flow control (XON and XOFF) to the computer in Transparent mode.	ON/ OFF	OFF
UICHECK	UIC	Does not forward the same UI packet as one received within the time specified by this command. The unit of the parameter is 1 second.	0 ~ 250	28
UIDIGI	UI	When receiving a UI packet which includes the parameter specified by this command, replaces the parameter with the MYCALL parameter and forwards the packet.	OFF/ ON Call1, ... call14	OFF
UIDWAIT	UIDW	When ON and digipeating, causes the TNC to use the DWAIT and PERSIST settings.	ON/ OFF	OFF
UIFLOOD	UIF	Specifies how received UI packets, which include WIDEN-N or TRACEN-N parameters, are processed. Enter WIDE or TRACE before ID, NOID, or FIRST; ex. WIDE, FIRST. With ID selected, deletes the relayed digipeaters and adds the MYCALL parameter. With NOID, merely decrements N-N; ex. 4-3 to 4-2. With FIRST, adds the MYCALL parameter only when serving as the first digipeater.	ID/ NOID/ FIRST	ID
UISSID	UIS	When ON, causes the TNC to process received UI packets depending on included destination SSIDs.	ON/ OFF	OFF
UITRACE	UIT	The command name must be followed by up to 5 alphanumeric characters; normally WIDE or TRACE. Causes the TNC to forward received UI packets which include WIDEN-N or TRACEN-N parameters.	-	-
UNPROTO	U	Specifies callsigns to send a packet in Unprotocol mode. Call1 is the callsign of the destination. Call2 to call9 are callsigns of stations to be digipeated through.	Call1 (VIA call2, call3)	CQ
USERS	US	Specifies the number of channels available to connect requests.	0 ~ 10	1
WRITE	W	Allows the TNC mailbox to store your message. In order to permit only a specific station to read your message, enter a callsign after the command name; ex. W JA1YKX. To complete message entry, press [Enter] (or [Return]), [Ctrl]+[C], then [Enter] (or [Return]). For a subject, you can enter up to 30 alphanumeric characters.	-	-
XFLOW	X	Causes the TNC to perform software flow control when ON, or hardware flow control when OFF.	ON/ OFF	ON

APRS DATA COMMUNICATION (APRS BEACON)

- ◆ This function uses the APRS format for data communications including your station position, messages, etc., when connected to a GPS receiver.
- ◆ Even with the GPS receiver not connected, similar communications can be performed by entering the position data.
- ◆ When data is received from another station, the direction of the received station (from your station's perspective), their distance, and their grid square locator is displayed. Any comments sent by the other station are also displayed.
- ◆ Meteorological data obtained from a connected Weather Station can be transmitted.
- ◆ APRS (Automatic Packet Reporting System) is a worldwide system introduced by Bob Bruninga, WB4APR .

< APRS® is a software program and registered trademark of Bob Bruninga, WB4APR.>
 Official APRS Website: <http://www.aprs.org>

NAVITRA DATA COMMUNICATION (NAVITRA BEACON)

- ◆ The Navitra system was introduced by Kenwood in the 1990's, for use within Japan.

CALLSIGN AND BEACON TYPE SETTINGS

- ◆ When an APRS/NAVITRA beacon is created, set the callsign and beacon type (APRS/NAVITRA) (Menu No. 600).



- ◆ SSID (Secondary Station Identifiers) can be added to the end of your callsign (for example, W6DJY will become W6DJY-14). SSIDs can range from "None, -1" to "-15", so that each callsign can have up to 16 settings.

Refer to the website for SSID: <http://aprs.org/aprs11/SSIDs.txt> (as of April 2011)

GPS RECEIVER SETTINGS

- ◆ When the GPS receiver is not connected to the TM-D710 (fixed station), set the GPS receiver Menu No. 602 (GPS PORT – INPUT) to [OFF] (default value). If you do not connect the GPS receiver when you set up [GPS], your station position location will not be correct, and the distance and direction of other stations will not be displayed. Therefore, you should set your position data using Menu No. 605 (MY POSITION).

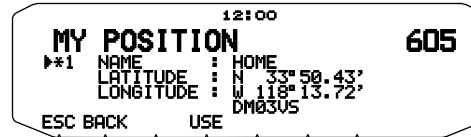
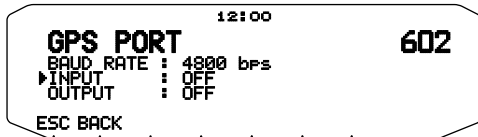

DIGIPEAT

- ◆ The term digipeat means that the packet data is relayed. When a digipeater (relay station) receives a packet, it saves it to memory. When the reception ends, the data is re-transmitted. Using digipeat, it is possible to send beacons long distances.
- ◆ In order to perform a digipeat, you must set up a packet path (Menu No. 612). For the packet path, you can specify a direct callsign or you can use "WIDE1-1" or "WIDE1-1, WIDE2-1", specifying a common alias and hops number. Set the transceiver's packet path according to the digipeater settings.
- ◆ Digipeat is very useful in reaching other stations when you have a weak signal. However, you need to set up the total hops numbers and beacon transmissions moderately to prevent channel congestion.

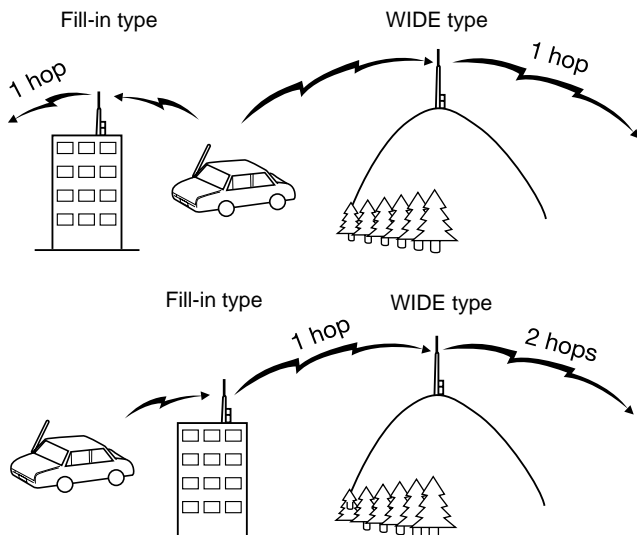

WIDE type:

This digipeater can send the packet over a wide area.

Fill-in type:

Regional digipeaters are also called "RELAY type" relays. These digipeaters are used for mobile stations when a signal cannot reach a WIDE-type digipeater.

CONNECTING WITH A GPS RECEIVER OR WEATHER STATION

The GPS jack on this transceiver accepts a 2.5 mm (1/10") 3-conductor plug. If necessary, use the supplied cable to modify the cable end of your GPS receiver or Weather Station.

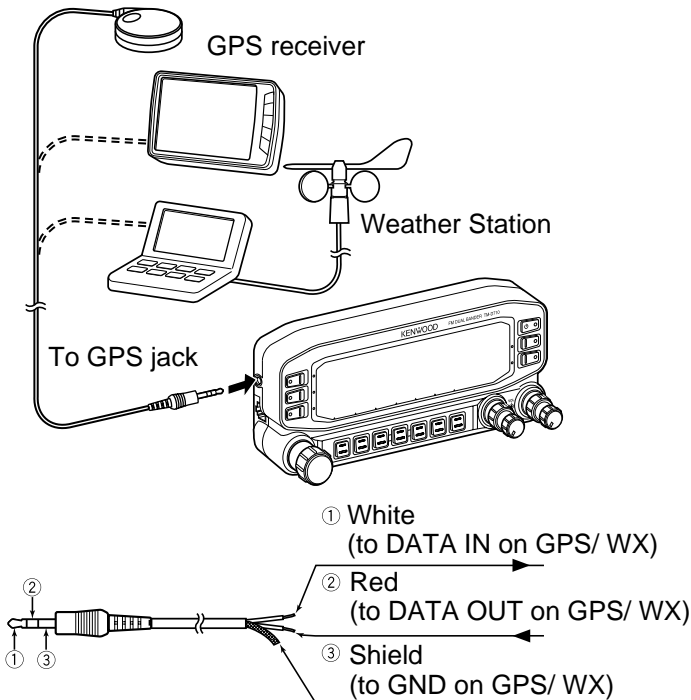

- Use a GPS receiver which conforms to the NMEA-0183 format and is compatible with RS-232C signal polarity output at the below mentioned levels.
[Low level: $-15.0V \sim +0.5V$ / High level: $+3.0V \sim +15.0V$]
You cannot use GPS receivers with USB-type connections.
- Set Menu No. 602 (GPS PORT-INPUT) to "GPS" (GPS receiver), "WEATHER (Davis)" (Weather Station), or "WEATHER (PeetBros.)" (Weather Station), depending on the equipment connected to the GPS terminal.
When a GPS receiver is selected, the "GPS" indicator appears. When a Weather Station is selected, the "WXI" indicator appears.
- The "GPS" indicator blinks while positioning.

ADJUSTING THE INTERNAL CLOCK

This transceiver has a clock to manage information on when APRS packets are received. Use Menu Set-up to correct the current time, date, and if necessary the UTC offset; UTC stands for Universal Time Coordinated.

The year, month, day, and time are automatically set from the GPS satellite information. If the GPS information cannot be received, you can manually enter the date and time.

Note: The battery for the clock backup is built into the unit. When the power source is connected, the battery begins to charge. It takes approximately 12 hours to become fully charged.

Setting Date

- Enter Menu mode and access Menu 524.
 - The first 2 digits blink.

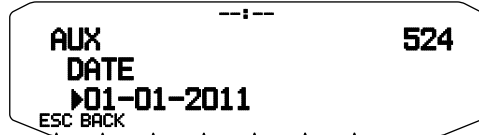

- Rotate the **Tuning** control to enter the current month (K type) or day, then press the **Tuning** control.
 - The next 2 digits blink.
- Rotate the **Tuning** control to enter the current day (K type) or month, then press the **Tuning** control.
 - The last 2 digits blink.
- Rotate the **Tuning** control to enter the current year, then press the **Tuning** control.
- Press [**ESC**] to exit Menu mode.

Note:

- When used at room temperature (25°C), the error of the internal clock in a month is within one minute.
- The internal clock is effective until December 31, 2099.

Setting Time

- Enter Menu mode and access Menu 525.
 - The first 2 digits blink.

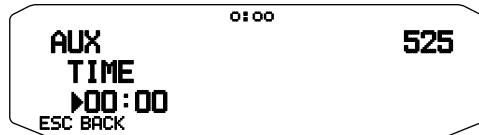

- Rotate the **Tuning** control to enter the current hour, then press the **Tuning** control.
 - To set 1 o'clock PM for example, select 13.
 - The next 2 digits blink.
- Rotate the **Tuning** control to enter the current minute, then press the **Tuning** control.
- Press [**ESC**] to exit Menu mode.

Setting UTC Offset

- Enter Menu mode and access Menu 526.

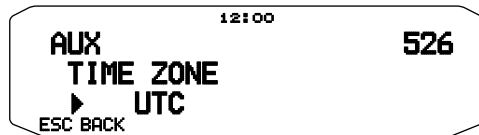

- Rotate the **Tuning** control to select the appropriate UTC offset, then press the **Tuning** control.
 - The selectable range is from +14:00 to -14:00 in steps of 15 minutes.
- Press [**ESC**] to exit Menu mode.

RECEIVING APRS DATA

Each time a new APRS packet is received, the frequency display is interrupted to show information as below:

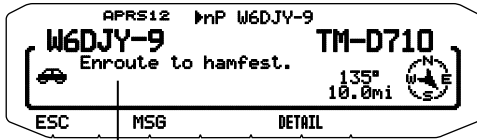

Status text

- The received APRS packet may include information on an object such as a hurricane or tornado. In this case, the name of the object appears instead of a call sign.
- Press **[MSG]** to send a message to the station.
- Press **[DETAIL]** to access further information.
- To restore the frequency display, press **[ESC]** or just wait for approximately 10 seconds.

Note:

- ◆ When you receive an APRS packet including an "EMERGENCY" comment, a different format of display from the above will appear and a different beep will sound.
- ◆ When you receive an APRS position packet that you transmitted, the frequency display is interrupted and "MY POSITION" will appear on the display. This could happen when one or more digipeaters are used. (When setting Menu No. 625 (DISPLAY AREA) to "ENTIRE", "HALF", or "OFF", the call sign of the digipeater station will not display.)

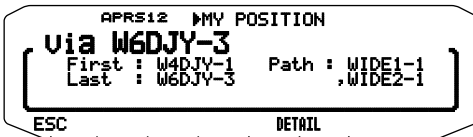

- ◆ If you receive a message that you transmitted, "MY MESSAGE" will appear.

- You can change the interrupt screen display setting through Menu No. 625 (DISPLAY AREA). When set to "OFF", the frequency display is not interrupted. An indicator such as "dP" appears, depending on the type of data. Refer to the table for details.

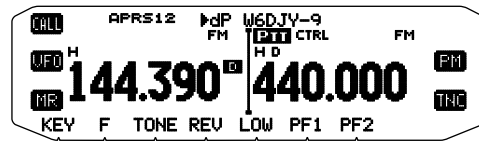

Indicator	Meaning
dP	Duplicate position comment
nP	New position data
oP	Other station position data (Navitra beacon)
>P	Beyond position limit
>F	Beyond filter type
aM	ACK message
dM	Duplicate message data
nM	New message data
oM	To other stations message data
rM	Rejected Message
dS	Duplicate status text
nS	New status
Q? ¹	Query
??	Packet that cannot be decoded
dD	Duplicated DX cluster data
nD	New DX cluster data

¹ The transceiver automatically transmits the appropriate information in approximately 2 minutes after receiving a request.

Note:

- ◆ The APRS programs for PCs have entry fields for a position comment and status text. The data entered to these two fields are transmitted as separate packets. This transceiver, however, includes both of a position comment and status text in one packet to transmit.
- ◆ This transceiver beeps each time it receives any type of APRS packet. You may access Menu 624 (AUDIO - RX BEEP) to change this setting. The default is "ALL".

ACCESSING RECEIVED APRS DATA

This transceiver is capable of receiving and storing APRS data received from up to 100 stations in memory. You can easily recall the information of the desired station.

1 Press [KEY], [LIST].

- The list of stations appears.
- The numbers beside the callsigns indicate the order in which data is received. The data received last is assigned 1.

```

TOP  ▶ APRS12 STATION LIST
      1:W4DJY-13 11:14 Weather
      2:W6DJY    11:12 Fixed
      3:W6DJY-9  10:11 TM-D710
      4:W4DJY-7  09:44 TH-D72
      5:W5DJY-3  07:21 TM-D700
      ESC F MSG SORT FILTER TUNE CLR
  
```

[TOP]: Displays the list of the fast 5 stations.

[5↑]: Displays the list of the previous 5 stations.

[5↓]: Displays the list of the next 5 stations.

[ESC]: Restores the frequency display.

[MSG]: Allows message entry to the current station.

[SORT]: To select the sort function.

[FILTER]: To select the filter function.

[TUNE]: Set the QSY frequency (APRS only).

[CLR]: Deletes the current station.

- Press [F].

```

TOP  ▶ APRS12 STATION LIST
      1:W4DJY-13 11:14 Weather
      2:W6DJY    11:12 Fixed
      3:W6DJY-9  10:11 TM-D710
      4:W4DJY-7  09:44 TH-D72
      5:W5DJY-3  07:21 TM-D700
      OFF POS.RQ ALLCLR
  
```

[POS.RQ]: Request position.

[ALLCLR]: Deletes all stations.

- When you press [ALLCLR], "CLEAR ALL?" appears with the message. Press the Tuning Control to clear all.

2 Rotate the Tuning control to select the desired station using the cursor (▶).

3 Press the Tuning control.

- The information of the selected station appears.

```

APRS12 12:00
▶ 2:W6DJY 11:11 07/22
      Fixed
      Power 49W Gain 2dB
      Height 90' Dir omni 135°
      10.0mi
      BACK F MSG ← → TUNE CLR
  
```

[BACK]: Restores the list of stations.

[MSG]: Allows message entry to the current station.

[←]: Displays the previous page.

[→]: Displays the next page.

[TUNE]: Set the QSY frequency (APRS only).

[CLR]: Deletes the entire information of the current station.

CURSOR CONTROL

Select a cursor control setting for reception.

- Display the station list.
- Press [TOP] to change the cursor control between Followed mode and Fixed mode. The cursor display changes according to the selected mode.

Followed mode (▶): On the list screen, the cursor (▶) follows the callsign when receiving APRS data.

```

TOP  ▶ APRS12 STATION LIST
      1:W6DJY-9  15:08 TM-D710
      2:JA1VKX-7 15:01 TH-D72
      3:DF0TK-14 14:55 TM-D700
      4:W5DJY    14:52 Fix
      5:9UKW-13  14:49 Weather
      ESC F MSG SORT FILTER TUNE CLR
  
```

```

TOP  ▶ APRS12 STATION LIST
      1:W4DJY-7  15:32 TM-D72
      2:W6DJY-9  15:08 TM-D710
      3:JA1VKX-7 15:01 TH-D72
      4:DF0TK-14 14:55 TM-D700
      5:W5DJY    14:52 Fix
      ESC F MSG SORT FILTER TUNE CLR
  
```

Fixed mode (▶): On the list screen, the cursor (▶) sits at the list number when receiving APRS data.

```

TOP  ▶ APRS12 STATION LIST
      1:W6DJY-9  15:08 TM-D710
      2:JA1VKX-7 15:01 TH-D72
      3:DF0TK-14 14:55 TM-D700
      4:W5DJY    14:52 Fix
      5:9UKW-13  14:49 Weather
      ESC F MSG SORT FILTER TUNE CLR
  
```

```

TOP  ▶ APRS12 STATION LIST
      1:W3DJY-7  15:18 TH-D7
      2:W6DJY-9  15:08 TM-D710
      3:JA1VKX-7 15:01 TH-D72
      4:DF0TK-14 14:55 TM-D700
      5:W5DJY    14:52 Fix
      ESC F MSG SORT FILTER TUNE CLR
  
```

Note:

- When data from the 101st station is received, the oldest data in memory is replaced by that data.
- Each time a new APRS packet is received from the same station, the old data from that station (in memory) is replaced by new data.

DISPLAY EXAMPLE

Page 1

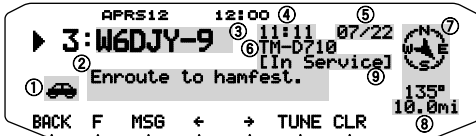

- ①: Station icon
- ②: Status text
- ③: Callsign
- ④: Time (packet received)
- ⑤: Date
- ⑥: Situation
- ⑦: Direction of station
- ⑧: Distance from station (mile or km)
- ⑨: Position comment ¹

¹ For packets received from Mic-encoder stations including TM-D710s, TM-D700s, TH-D72s, and TH-D7s, position comments are displayed in the fourth line.

(Object)



- ①: Object

Page 2

(Mobile station)

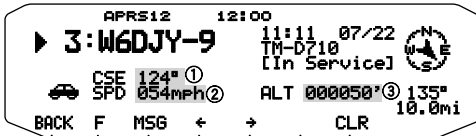

- ①: Moving direction
- ②: Moving speed (mph: Mile/hour or kph: km/hour)
- ③: Altitude (': Feet or M: Meter)

(Weather station)

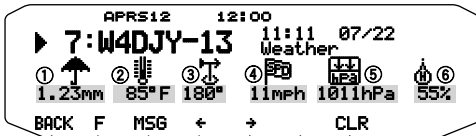

- ①: Rainfall (" or mm)
- ②: Air temperature
- ③: Wind direction
- ④: Wind velocity (mph: Mile/hour or kph: km/hour)
- ⑤: Atmospheric pressure
- ⑥: Humidity

(Fix station)

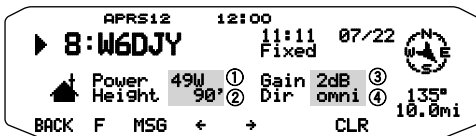

- ①: Transmit power
- ②: Height of antenna (elevation) (': Feet or M: Meter)
- ③: Antenna gain
- ④: Antenna directivity

Page 3

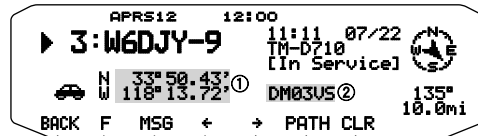

- ①: Position data
- ②: Grid square locator (Packet path)

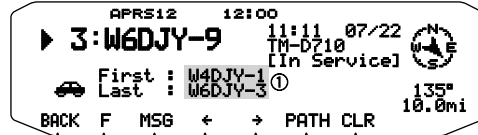

- ①: Callsign (Digipeater)

This transceiver is capable of displaying the following icons as station IDs.

<APRS>



<NAVITRA>



Some icons may appear with overlay characters as below if the received icon data includes them (APRS only).

Example:



The following icons show the directions of stations relative to your position.

(North Up)



(Heading Up: example)



- When pressing [F], [N/H] while the target point distance/traveling direction is displayed, the North Up display (displays North as the top) changes to the Heading Up display (displays the current travel direction as the top) or vice-versa. In the Heading Up display, a "+" or "-" is used to help indicate the traveling direction.

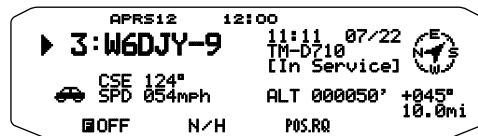

To change the speed/distance and/or temperature settings of the units, access Menu 626 (DISPLAY UNIT 1 - SPEED, DISTANCE) and/or Menu 626 (DISPLAY UNIT 1 - TEMPERATURE)

Note: Some stations transmit APRS packets through TNCs connected to GPS receivers. If you receive packets from those stations, "GOOD" (satellites tracked) or "LAST" (satellites not tracked) will be shown as the situation, with GLL, GGA, or RMC which designates \$GPGLL, \$GPGGA, or \$GPRMC format.

SORT FUNCTION

This function allows you to sort the station list according to the callsign, date time, or distance.

1 Display the station list.

```

TOP  ▶ APRS12 STATION LIST
      1:W4DJV-13 11:14 Weather
      2:W6DJV   11:12 Fixed
      3:W6DJV-14 11:11 TM-D700
      4:W4DJV-7  10:44 TH-D72
      5:W5DJV-9  10:13 TM-D710
      ESC F MSG SORT FILTER TUNE CLR
  
```

2 Press [SORT].

- The sort type list appears on the display.

```

APRS12 STATION LIST
<SORT>
by CALLSIGN
▶by DATE/TIME
by DISTANCE
      ESC
  
```

3 Select a sort type.

4 Press the **Tuning** control.

- “SORTING” appears on the display and sorting begins.

```

APRS12 STATION LIST
SORTING!
      ESC
  
```

CALLSIGN	All callsigns are compared and arranged in ascending order.
DATE/TIME	All received dates and times are compared and arranged in descending order, with the last received message listed first.
DISTANCE	The distance between the other station and My station when selecting the sorting method is calculated, then compared and arranged in ascending order, with the closest station listed first.

5 The newly sorted station list appears on the display.

```

TOP  ▶ APRS12 STATION LIST
      1:W5DJV-9  10:13 TM-D710
      2:W4DJV-7  10:44 TH-D72
      3:W6DJV-14 11:11 TM-D700
      4:W6DJV   11:12 Fixed
      5:W4DJV-13 11:14 Weather
      ESC F MSG SORT FILTER TUNE CLR
  
```

- After sorting, when new station data is received, it is added to the station list without resorting.

DISPLAY FILTER FUNCTION

This function allows you to display only the specified types of data from the station list.

1 Display the station list.

```

TOP  ▶ APRS12 STATION LIST
      1:W4DJV-13 11:14 Weather
      2:W6DJV   11:12 Fixed
      3:W6DJV-14 11:11 TM-D700
      4:W4DJV-7  10:44 TH-D72
      5:W5DJV-9  10:13 TM-D710
      ESC F MSG SORT FILTER TUNE CLR
  
```

2 Press [FILTER].

- The filter type list appears on the display.

```

APRS12 STATION LIST
<FILTER>
by ALL(OFF)
by DIGIPEATER
▶by WEATHER
by MOBILE
by OBJECT
by KENWOOD
by NAVITRA
by FREQUENCY(QSY)
by OTHERS
      ESC
  
```

3 Select a filter type.

4 Press the **Tuning** control.

- “FILTERING” appears on the display and filtering begins.

```

APRS12 STATION LIST
FILTERING!
      ESC
  
```

DIGIPEATER	Only Digipeater Stations are displayed.
WEATHER	Only Weather Stations are displayed.
MOBILE	Only Mobile Stations are displayed.
OBJECT	Only Object Stations are displayed.
KENWOOD	Only Kenwood TH-D7, TH-D72, TM-D700, TM-D710, and RC-D710 Stations are displayed.
NAVITRA	Only Navitra Stations starting from \$PNTS are displayed.
FREQUENCY (QSY)	Only stations containing frequency (QSY) data are displayed.
OTHERS	Stations other than those listed above are displayed.
ALL(OFF)	The filtering function is cancelled, displaying all stations.

5 The newly filtered station list appears on the display.

```

TOP  ▶ APRS12 STATION LIST
      1:9U1KW-13 11:14 Weather
      2:W6DJV-13 11:44 Weather
      ESC F MSG SORT FILTER TUNE CLR
  
```

- After the display filter function is turned ON, received data is added to the list but will not be displayed if it matches the filter type selected.
- For example, with the station list displayed and the display filter selection set to “WEATHER”, all stations not relating to weather are no longer displayed. If mobile station data is received at this time, the new data will also not be displayed as long as the weather filter is active.

RECEIVING A MESSAGE

Each time a proper message is received, the frequency display is interrupted to show information as below:



- ①: Indicator
- ②: Callsign (TX)
- ③: Receive time
- ④: Message
- ⑤: TX/RX date
- ⑥: Line number
- The display shows up to 67 characters of the message.
- "B01" will appear to indicate the number of messages not yet read.
- The following indicators appear depending on the types of received messages:

Indicator	Meaning
B	Message addressed to you
B	Bulletin message
!	Report by the National Weather Service
*	Reception acknowledgment (or rejection) to your message
G	Message group

- "BXX" appears on the display when you have an unread message (where XX is the number of unread messages). When you verify the reception of a message (by pressing the Tuning control), the message is marked as read. For each message you view, then number (XX) decreases by 1. When only 1 message is unread ("B01"), viewing this message will cause the B icon to be removed from the display. (When you enter the message list display and select a message designated as unread by the "BXX" mark, the message will be marked as read.)

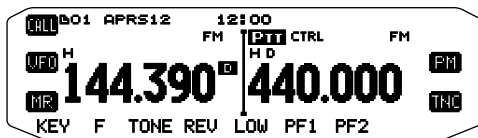

- When a duplicate message from the same station is received, the reception interrupt display does not appear and an error tone sounds. When the frequency at that time appears on the display, "dM" (duplicate Message) and the calling station's callsign appears on the display.

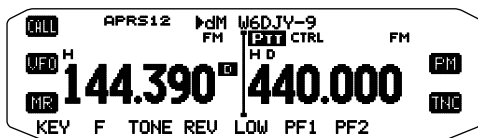

Note:

- ◆ This transceiver allows you to receive a message also when the SSID does not match. However, it will not return a reception acknowledgment.
- ◆ The dedicated memory is used for storing both incoming and outgoing messages. Receiving a new message when the memory is full causes the oldest message to be deleted. A message not yet transmitted 5 times may be unexpectedly deleted. If the oldest message has not been accessed using the List function when memory is full, a new message does not replace the oldest message. This transceiver will return a reject command and display "rM".
- ◆ This transceiver beeps each time it receives any type of APRS packet. You may access Menu 624 (SOUND-RX BEEP) to change this setting. The default is "ALL".

ENTERING A MESSAGE

To transmit a message, first enter the callsign of the target station. To transmit a bulletin, enter "BLN#" instead; where # must be 0 to 9 or A to Z. When the length of your bulletin exceeds 64 digits, you may transmit more than one packet to send the entire bulletin. Use # to indicate the sequence of the bulletin portions. For example, enter "BLN0" (or "BLNA") to send the first packet, then "BLN1" (or "BLNB") to send the second packet.

- 1 Press [KEY], [MSG].



- 2 Press [NEW] or [REPLY].

- The display for entering a callsign appears; the first digit blinks. (When you press [REPLY], not necessarily)

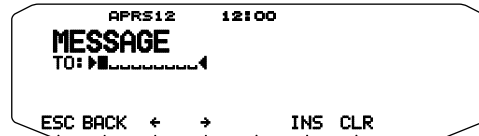

[BACK]: Cancels entry of a callsign.

[←]: Causes the cursor to move backward.

[INS]: Inserts the currently selected character.

[CLR]: Deletes the digit at which the cursor is blinking.

- 3 Rotate the Tuning control to select the first digit.

- You can enter 0 to 9, A to Z, and -.

- 4 Press the Tuning control.

- The cursor moves to the next digit.

- 5 Rotate the Tuning control to complete the setting.

- The display for entering a message appears; the first digit blinks.



[SPACE]: Inserts a space

- To copy a message, enter message compilation mode, press [F] to enter function mode, then press [PASTE1], [PASTE2], [PASTE3], or [PASTE4] to copy the message that has been set up for each key.



[ALLCLR]: Clears all digits and backs the cursor to the first digit.

- 6 Rotate the Tuning control to select the first digit.

- You can enter alphanumeric characters plus special ASCII characters.

- 7 Press the Tuning control.

- The cursor moves to the next digit.

- 8 Repeat steps 6 and 7 to enter up to 67 digits.

- 9 Press the Tuning control to complete the setting.

The keypad on the microphone also is available to enter alphanumeric characters in steps 3 and 6.

ACCESSING RECEIVED APRS MESSAGES

This transceiver is capable of storing a maximum of 100 messages in memory. You can easily access one of those.

1 Press [KEY], [MSG].

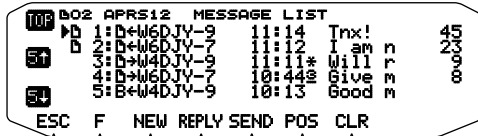

- The newer message the smaller number assigned; the latest message is assigned 1.

[POS]: Displays the latest position data of the current station, if stored in memory.

2 Rotate the Tuning control to select the desired message using the cursor (s).

3 Press the Tuning control.

- If you select an incoming message, the following display appears:



[BACK]: Restores the list of messages.

[NEW]: Create a new message.

[REPLY]: Responds to the party from whom you received. Enters into message setting.

[SEND]: Messages in the list that have not been sent are transmitted.

[POS]: The position data of the transmitting station is displayed (if the station data is available).

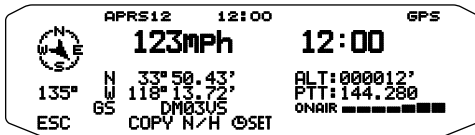

[COPY]: Copies the GPS position data to Menu No. 605 (MY POSITION).

[N/H]: Switches between North up and Heading up.

[SET]: Sets the date and time from the GPS receiver to the internal clock.

[CLR]: Deletes the current message.

- If you select one of your outgoing messages, the following display appears:



[BACK]: Restores the list of messages.

[NEW]: Create a new message.

[EDIT]: Allows you to edit the transmitted message.

[SEND]: All messages which can be transmitted will be sent 1 time.

[RE-TX]: When pressed for a message assigned a period (.), resets the retry counter to 5 more transmissions.

[CLR]: Cancels further transmissions of the current message.

The table below shows the meanings of the symbols to be shown in step 2.

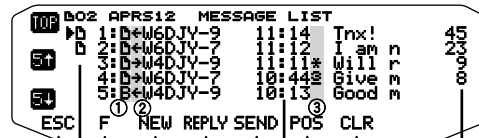

Not-yet-read indicator

Sequence

Time/Date < before today > (message received)

① Meaning	
D	Message addressed to you
B	Bulletin message
!	Report by the National Weather Service
② RX or TX?	
←	Received message (or bulletin)
→	A message (or bulletin) for transmitting
③ Status	
n ¹	"n" indicates the remaining number of times for transmitting the message (or bulletin).
* ¹	A message for which a reception acknowledgment was returned
. ¹	A message (or bulletin) transmitted 5 times (For a message, a reception acknowledgment was not returned.)

¹ These indicators appear for outgoing messages (or bulletins).

TRANSMITTING A MESSAGE

When you press [SEND] on the "MESSAGE LIST" display, the remaining messages on the Message List will be transmitted.



After entering a message on the message display, pressing the Tuning Control will cause it to transmit every minute.



BASIC SETTINGS

Enter Menu mode and access Menu 600.



■ My Callsign <MY CALLSIGN>

Program your callsign using a maximum of 9 alphanumeric characters. You may include SSID characters in the string. Unless you program a callsign, you cannot transmit APRS packets.

- 1 Select MY CALLSIGN.
 - The display for entering a callsign appears; the first digit blinks. The default is "NOCALL".
- 2 Rotate the **Tuning** control to select the first digit.
 - You can enter 0 to 9, A to Z, and –.
- 3 Press the **Tuning** control.
 - The cursor moves to the next digit.
- 4 Repeat steps 2 and 3 to enter up to 9 digits.

Note: When all settings are blank, "NOCALL" is automatically set. In this case, the Position packet or Message packet cannot be transmitted.

■ Beacon Type <BEACON TYPE>

[APRS]: Beacons are transmitted in APRS format when the "APRS" icon appears on the upper left of the display. Additionally, in Menu mode, only those menus which can be set with APRS are displayed.

[NAVITRA]: Beacons are transmitted in NAVITRA format when the "NAVITRA" icon appears on the upper left of the display. Additionally, in Menu mode, only those menus which can be set with NAVITRA are displayed.

SETTING INTERNAL TNC

Enter Menu mode and access Menu 601.

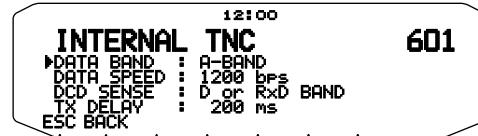

■ Data Band <DATA BAND>

On this transceiver you can select data band for APRS mode independent of the selection for Packet mode. Select band A or B as the data band for receiving or transmitting APRS packets. The default is band A. "D" indicates the current data band.

Note: In Menu 601, the selection switches among A-BAND, B-BAND, TX:A-BAND RX:B-BAND, and RX:A-BAND TX:B-BAND. Select TX:A-BAND RX:B-BAND or RX:A-BAND TX:B-BAND if APRS networks which use two separate frequencies become available in the future.

■ Packet Transfer Rate <DATA SPEED>

The default APRS packet transfer rate set on the built-in TNC is 1200 bps which is the standard among the current APRS networks. If APRS networks which use 9600 bps transfer rate become available in the future, select "9600 bps"

■ DCD Sense <DCD SENSE>

You can also select the method for inhibiting the built-in TNC from transmitting.

[D or RxD BAND]: When the data band is no longer busy (as per the steps below), the packet is transmitted.

- ① Press **[PTT]** to enter transmit mode.
- ② The data band is busy.

[BOTH BAND]: When the bands are no longer busy (as per the steps below), the packet is transmitted.

- ① Press **[PTT]** to enter transmit mode.
- ② The data band is busy.
- ③ The other band is busy.

[IGNORE DCD]: Transmission from the built-in TNC is not inhibited. The packet is transmitted immediately.

■ TX delay <TX DELAY>

This function allows you to set a transmission delay time between transmitting the APRS data and transmitting a flag code prior to the APRS data. When the other station has activated their Save Mode, set a longer delay time.

SETTING GPS PORT

Enter Menu mode and access Menu 602

```
12:00
GPS PORT 602
BAUD RATE : 4800 bps
INPUT      : OFF
OUTPUT     : OFF
ESC BACK
```

■ Baud Rate <BAUD RATE>

Set the communication speed of the external GPS or other equipment that is connected to the GPS terminal. The speed is set to 4800 bps (NMEA)/ 9600 bps (IPS format: SONY) when a GPS receiver is connected.

- It does not correspond to the Gamin-TXT format.

■ Input Type <INPUT>

[OFF]: You can perform APRS communications without the use of a GPS receiver or Weather Station. Set your station position data manually through Menu No. 605 (MY POSITION).

[GPS]: You can perform APRS communications using a GPS receiver. Verify your station position data by pressing the **[POS]** key.

[WEATHER (Davis)]: You can perform APRS communications using a Davis Weather Station. Verify your station weather data by pressing the **[WXi]** key.

- Operation verification model (as of April 2011)
Vantage PRO2™
- Please use the Data Logger bundled with "WeatherLink® for Vantage Pro2™, Windows, Serial Port" (Davis Part No.06510SER) or "WeatherLink® for APRS, with Streaming Data Logger" (Davis Part No.06540) with Vantage PRO2™.
- When using the "WeatherLink® for APRS, with Streaming Data Logger" (Davis Part No.06540) Data Logger, set the BAUD RATE (Menu No.602) to 9600bps for stable operation.

[WEATHER (PeetBros.)]: You can perform APRS communications using a PeetBros Weather Station. Verify your station weather data by pressing the **[WXi]** key.

- Operation verification model (as of April 2011)
ULTIMETER® 2100 (Packet mode)

■ Output Type <OUTPUT>

[WAYPOINT]: Waypoint information is forwarded. The callsign and positioning data received from another station can be displayed as the waypoint data through the device connected to your GPS receiver or on the GPS receiver display.

[DGPS]: Differential GPS information is forwarded. The differential information which is received in the beacon from a reference station (amateur radio station), is sent to the GPS receiver.

SETTING WAY POINT

Enter Menu mode and access Menu 603.

```
12:00
WAYPOINT 603
FORMAT : NMEA
NAME   : 6-CHAR
OUTPUT : ALL
ESC BACK
```

■ Way Point Format <FORMAT>

Select the type of Way point Format that is sent.

[NMEA]: The data which is output from the GPS terminal using the NMEA-0183 "\$GPWPL" format.

[MAGELLAN]: The data which is output from the GPS terminal using the "\$PMGNWPL" format.

[KENWOOD]: The data which is output from the GPS terminal using the "\$PKWDWPL" format.

■ Way Point Name <NAME>

Select the length of the Way Point Name. The length can be set as [6-CHAR], [7-CHAR], [8-CHAR] or [9-CHAR].

■ Way Point Output <OUTPUT>

[ALL]: All Way point information is sent.

[LOCAL]: If the position limit is ON, all the data within the position limit is sent. If the position limit is OFF, all Way point data is sent.

[FILTERED]: Information that is permitted using the packet filter is output as Way point information.

COM PORT ON/OFF

Enter Menu mode and access Menu 604.

```
12:00
COM PORT 604
OUTPUT : OFF
ESC BACK
```

■ Output <OUTPUT>

This function outputs data from the COM port after receiving packet and TNC command data from the APRS data communications. Use this function to verify the received data from the transceiver.

PROGRAMMING POSITION DATA

Enter Menu mode and access Menu 605.

```

12:00
MY POSITION 605
*1 NAME : HOME
LATITUDE : N 33° 50.43'
LONGITUDE : W 118° 13.72'
DM0305
ESC BACK USE
    
```

■ Select Position channel

This transceiver has 5 memory channels for storing position data. Program latitude and longitude data for up to 5 locations from which you will often transmit APRS packets. You can also name the 5 memory channels.

■ Name Entry <NAME>

You can enter alphanumeric characters plus special ASCII characters (up to 8 digits).

■ Latitude Entry <LATITUDE>

The north/ south latitude is entered.

■ Longitude Entry <LONGITUDE>

The east/ west longitude is entered.

Note: When selecting GPS in Menu 602 (GPS PORT), the position information where it is set is not used.

SETTING BEACON INFORMATION

Enter Menu mode and access Menu 606.

```

12:00
BEACON INFORMATION 606
SPEED : ON
ALTITUDE : ON
POSITION AMBIGUITY : OFF
ESC BACK
    
```

■ Speed Information <SPEED>

Select whether or not to transmit speed information when using APRS data communications.

■ Altitude Information <ALTITUDE>

Select whether or not to transmit altitude information when using APRS data communications.

- When the beacon type is "NAVITRA", this information will not appear on the display.

■ Position Ambiguity <POSITION AMBIGUITY>

There may be cases where you do not know or do not want to report your precise locations. For position data, you can select the number of digits not to be included in your packets. Select 1 to 4, or OFF (default). The table shows how the digits are cleared.

OFF	1-DIGIT	2-DIGIT	3-DIGIT	4-DIGIT
33°50.43	33°50.4	33°50.	33°5 .	33° .
118°13.72	118°13.7	118°13.	118°1 .	118° .

- When the beacon type is "NAVITRA", this information will not appear on the display.

SELECTING A POSITION COMMENT

Enter Menu mode and access Menu 607.

```

12:00
POSITION COMMENT 607
Off Duty
ESC BACK
    
```

The APRS data which you transmit always includes one of the 15 predetermined position comments. Select an appropriate comment depending on your situation.

The selectable comments are listed below:

[Off Duty] [Enroute] [In Service] [Returning] [Committed] [Special] [PRIORITY] [CUSTOM 0 ~ CUSTOM 6] [EMERGENCY!]

- If you select "Emergency!", a confirmation message appears. Press the Tuning control again.

```

12:00
POSITION COMMENT 607
EMERGENCY!
Are you sure?
ESC BACK
    
```

ATTENTION: When it is unnecessary, never "EMERGENCY!". When an emergency signal is received using APRS, the Emergency Alarm on all stations will sound.

STORING STATUS TEXT

Enter Menu mode and access Menu 608.

```

12:00
STATUS TEXT 608
*1 TEXT :
TX RATE : OFF
ESC BACK USE
    
```

■ Text <TEXT>

Status text is another comment to transmit with position data. Unlike a position comment, you can make any desired comment using a maximum of 42 alphanumeric characters. This transceiver has 5 memory channels for preprogramming.

- Select a status text number.

```

12:00
STATUS TEXT 608
*2 TEXT :
TX RATE : OFF
ESC BACK USE
    
```

- Press [USE] to mark the currently used status text with [*].

- Enter your status text.

```

12:00
STATUS TEXT 608
*2 TEXT : [XXXXXXXXXXXXXXXXXXXXXXXXXXXXXXXXXXXX]
TX RATE : OFF
ESC BACK ← → SPACE INS CLR
    
```

■ Text Transmit Frequency <TX RATE>

Select the frequency on which to transmit the status text when the APRS beacon is transmitted. You can select [OFF], or [1/1] ~ [1/8] (APRS only).

- 1/X means the status text will be transmitted X number of times.

QSY FUNCTION

The QSY function uses AFRS (Automatic Frequency Reporting System) to report a frequency on which voice communications can be established. A station using the QSY function embeds the frequency information in a position beacon transmission. A receiving station of this information can change frequency, or QSY, over to the reported voice frequency to begin voice communication by the select of [TUNE].

Transmitting QSY Information

A properly configured functioning TM-D710 QSY station can automatically embed the voice frequency from the non-data band to the beginning of status text. This is the mechanism used for automatically transmitting the frequency information.

The format of the transmitted frequency is FFF.FFF MHz.

So, for example, if at the time of a beacon transmission, the non-data band has a frequency of 446.100 MHz selected, then the frequency of "446.100MHz" gets embedded to the beginning of the status text. If you configure in any of Statuses 1 through 4 the frequency of "446.100MHz" at the beginning of the status text messages, then this fixed frequency will be transmitted as QSY information along with the beacon transmission. In addition to frequencies, there are fields where you can send other settings such as Wide/Narrow, Tone/CTCSS/DCS, Shift (+/-), and Offset frequency simply by -leaving one space between each value. Therefore, other information besides just a frequency can be sent.

QSY Information Format:

(Insert one space after the frequency before entering Wide/Narrow, Tone/CTCSS/DCS and Shift/Offset.)

- "T079": An upper case "T" indicates Wide. Tone frequency of 79.7 Hz. (Encoding)
- "t079": A lower case "t" indicates Narrow. Tone frequency of 79.7 Hz. (Encoding)
- "tOFF": A lower case "t" indicates Narrow. Tone = OFF (Without any tone Encoding or Decoding.)
- "C079": An upper case "C" indicates Wide. CTCSS frequency of 79.7 Hz. (Encoding/ Decoding)
- "c079": A lower case "c" indicates Narrow. CTCSS frequency of 79.7 Hz. (Encoding/ Decoding)
- "D023": An upper case "D" indicates Wide. DCS code of 023. (Encoding/ Decoding)
- "d023": A lower case "d" indicates Narrow. DCS code of 023. (Encoding/ Decoding)
- "+": Plus Shift (A default offset frequency is applied.)
- "-": Minus Shift (A default offset frequency is applied.)
- "+500": Plus Shift, 5 MHz Offset
- "-060": Minus Shift, 600 kHz Offset

The value of the Offset shall be a 3-digit number. (x 10 kHz/ 50 kHz step)

Operation when Receiving a QSY

- 1 Select text setting number 5.
 - Frequency information is imbedded to the first 10 characters of the status text message.

```
12:00
STATUS TEXT 608
▶ 5 TEXT : [Frea MHz]
TX RATE : OFF
ESC BACK USE
```

- 2 Enter the status text message.

```
12:00
STATUS TEXT 608
▶ 5 TEXT : ▶[Frea MHz]
TX RATE : OFF
ESC BACK ← → SPACE INS CLR
```

- 3 When QSY (frequency) information is received, the station list appears (list summary and details) with the verified frequency. Press [TUNE].

```
APRS12 STATION LIST
1:W5D JY-9 11:14 TM-D710 439.640
2:W4D JY-7 10:12 TM-D710 145.040
3:W6D JY 10:11 Fixed 439.020
ESC F MSG SORT FILTER TUNE CLR
```

- The QSY (frequency) is set to the non data band.

Note: When using 6.5 kHz or 12.5 kHz step values, the display does not indicate values for 100 Hz and lower.

SETTING PACKET FILTER

Enter Menu mode and access Menu 609.

```
12:00
PACKET FILTER 609
POSITION LIMIT : OFF
TYPE : *WEATHER *DIGI
*MOBILE *OBJECT
*NAUITRA *OTHERS
ESC BACK SELECT
```

Position Limit <POSITION LIMIT>

If APRS is popular in your area, you may receive too many APRS packets for a short period. If this disturbs your APRS activities, specify a distance from your location. You will not receive APRS packets from stations beyond this distance.

Select the range from 10 to 2500 in steps of 10, plus OFF (default). The unit is mile or kilometer depending on the selection in Menu 626 (DISPLAY UNIT 1).

Packet Filter Type <TYPE>

The APRS position data is filtered.

- Check the type(s) you want to receive.
- If all types are checked, you will receive all types of data.

Refer to the website for QSY Information Format:
<http://aprs.org/info/freqspec.txt> (as of April 2011)

SELECTING YOUR STATION ICON

Enter Menu mode and access Menu 610.



Select an icon which will be displayed on the monitors of other stations as your ID. You may select an icon depending on your current location.

It is important that the icon conveys the operational status of the station as well as the SSID. You can display and set the following icons for the TM-D710.

W	KENWOOD (/K)	E	Eyeball (/E)
L	Lighthouse (/L)	K	School (/K)
S	Satellite (/S)	L	PC user (/L)
U	SUNNY (/U)	O	Balloon (/O)
Y	RADIO (/Y)	P	Police (/P)
a	ARRL (/a)	R	RV (/R)
c	RACES (/c)	S	SHUTTLE (/S)
g	Gale Flags (/g)	T	SSTV (/T)
h	HAM store (/h)	Y	Sailboat (/Y)
j	WorkZone (/j)	I	Person (/I)
Value Singpost	Speedpost (Value Singpost) (/m)	A	DF station (/A)
n	Triangle (/n)	WX	WX (Weather station) (/WX)
o	Small circle (/o)	/	Dish Antenna (/ /)
t	Tornado (/t)	b	Bicycle (/b)
x	Wreck (/x)	H	HOSPITAL (/h)
!	Sheriff (/!)	j	Jeep (/j)
#	Digipeater (/#)	k	Truck (/k)
&	GATEway (/&)	m	Mic-E Repeater (/m)
/	Aircraft (/ /)	n	Node (/n)
+	Red Cross (/+)	p	ROVER (/p)
-	Home (/ -)	r	QSO Repeater (/r)
.	X (/.)	s	Boat (/s)
/	Red Dot (/ /)	u	Truck (18-wheeler) (/u)
:	Fire (/ :)	v	Van (/v)
;	Portable (Tent) (/ ;)	.	Big Question Mark (/.)
<	Motorcycle (/ <)	0	IRLP/EchoLink (/0)
=	REILROAD ENGINE (/ =)	A	APRS (/A)
>	Car (/ >)		
B	BBS (/B)		
C	Canoe (/C)		

APRS supports approximately 200 icons. It allows users to select each icon by specifying a combination of two ASCII codes, for example, ! and /. One is a symbol code, and the other is a table identification code (either / or \). If you select "OTHERS", use the following procedures:

- 1 Rotate the **Tuning** control to select a symbol code, then press the **Tuning** control.



- 2 Rotate the **Tuning** control to select a table identification code, then press the **Tuning** control.



- **Overlay Icon Setting**

For example, to set the Digipeater icon to the letter "S", select "OTHERS" under the icon type menu, select "#" under "SYMBOL", then select "S" under "TABLE".

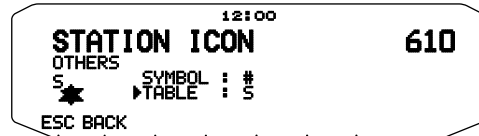

Note:

- ◆ APRS icon codes (symbols/tables) are sometimes updated. Please refer to the following official APRS website (as of April 2011):
<http://www.aprs.org/symbols/symbolsX.txt>
<http://aprs.org/symbols/symbols-new.txt>
- ◆ Set an icon that represents your operational status. (For example, setting an Aircraft icon or Balloon icon to a fixed station will cause confusion when a station receives a beacon.)

SETTING BEACON TX ALGORITHM

Enter Menu mode and access Menu 611.



■ Packet Transmit Method <METHOD>

Select the operation method for transmitting APRS packets. The table concludes how operations differ depending on the selection.

[MANUAL]:

Each press of [BCON] transmits your APRS packet.

[PTT]:

1 Press [BCON] to switch the function ON.

- "BCON" appears and blinks.

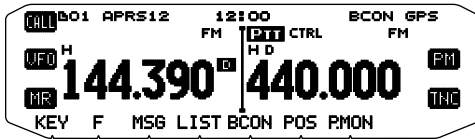

2 Press and hold the microphone [PTT], then speak into the microphone.

3 Release the microphone [PTT].

- Releasing the switch transmits your APRS packet.
- You cannot retransmit an APRS packet unless the time selected in <TX INTERVAL > passes. Wait until "BCON" starts blinking to indicate transmitting is ready.

4 To switch the function OFF, press [BCON] again.

[AUTO]:

1 Press [BCON] to switch the function ON.

- "BCON" appears.
- Switching the function ON transmits your APRS packet once. After that, APRS packets are automatically transmitted at intervals of the period selected in <TX INTERVAL >.

2 To switch the function OFF, press [BCON] again.

[SmartBeaconing]:

1 Press [BCON] to switch the function ON.

- "BCON" appears and blinks.
- After manually transmitting your station position data 1 time, your position data will be automatically transmitted using the time interval set under "SmartBeaconing" <Menu No. 630 and 631>.

2 To switch the function OFF, press [BCON] again.

Note: After setting "SmartBeaconing", the TX Interval Time, Decay Algorithm and Proportional Pathing features will no longer operate.

■ TX Interval Time <TX INTERVAL>

You can change the interval for automatically transmitting APRS packets. Access <TX INTERVAL > and select 0.2, 0.5, 1, 2, 3, 5, 10, 20, 30 or 60 minutes. The default is 3 minutes.

Note:

- ◆ With "AUTO" in <METHOD > and Beacon ON, pressing the **Tuning** control to complete the setting causes the APRS packet to be immediately transmitted. After that, APRS packets are transmitted at intervals of the selected period.
- ◆ While signals are present, an APRS packet is not transmitted after the interval. After signals drop, transmitting is executed.

■ Decay Algorithm <DECAY ALGORITHM>

This function continuously extends the packet transmission interval in the case that there is no change of position information.

- When the position data does not change, the data is transmitted based on a Decay Algorithm (1 minute, 2 minutes, 4 minutes, 8 minutes, 16 minutes, 32 minutes, 32 minutes, 32 minutes, etc.)
- When My station position data changes, the data is transmitted using an interval time based on the set Initial Interval.
- When the set time elapses and transmission is performed but a busy signal is present, the transceiver does not transmit. When there is no longer a busy signal, the transceiver attempts to transmit.

Note:

- ◆ While transmitting by pressing the [PTT] switch, beacon transmission is reserved.
- ◆ If My callsign is not set, the APRS packet will not be transmitted.
- ◆ Independent of this interval, the transmission of the message is in 1 minute intervals.

■ Proportional Pathing <PROPORTIONAL PATHING>

This function automatically changes the transmit packet path with the elapsed time.

Operation example for when PROPORTIONAL PATHING = ON

Transmission interval is 2 minutes. (When the <DECAY ALGORITHM> = ON, the decay transmission interval takes precedence.)

The packet path changes with each transmission as shown below (when the packet path is set as WIDE1-1, WIDE2-1).

2 minutes : DIRECT

4 minutes : WIDE1-1 (1 Hop)

6 minutes : DIRECT

8 minutes : WIDE1-1, WIDE2-1 (2 Hops)

10 minutes : DIRECT

12 minutes : WIDE1-1 (1 Hop)

14 minutes : DIRECT

16 minutes : WIDE1-1, WIDE2-1 (2 Hops)

This is repeated.

When jointly using a Decay Algorithm, if the speed is 1 knots or slower, a Decay Algorithm pattern is used for transmitting, but if the speed is 3 knots or faster, it changes to Proportional Pathing.

PROGRAMMING A PACKET PATH

Enter Menu mode and access Menu 612.

```

12:00
PACKET PATH 612
TYPE : *New-N PARADIGM
WIDE1-1 : ON
TOTAL HOPS : 2
PATH IS VIA: WIDE1-1,WIDE2-1
ESC BACK USE
  
```

Select the packet path type from [New-N PARADIGM], [RELAY PARADIGM], [STATE/SECTION/REGION], or [OTHERS].

When you press [USE], the “*” indicator appears on the left side of the packet path type, showing the current used information.

[New-N PARADIGM]:

This digipeat type has been used mainly in North America, but is now used worldwide.

- 1 Set the TYPE to [New-N PARADIGM], then press [USE].

```

12:00
PACKET PATH 612
TYPE : *New-N PARADIGM
WIDE1-1 : ON
TOTAL HOPS : 2
PATH IS VIA: WIDE1-1,WIDE2-1
ESC BACK USE
  
```

- 2 Set WIDE 1-1 to [OFF] or [ON].

```

12:00
PACKET PATH 612
TYPE : *New-N PARADIGM
WIDE1-1 : ON
TOTAL HOPS : 2
PATH IS VIA: WIDE1-1,WIDE2-1
ESC BACK USE
  
```

- Set WIDE 1-1 to [ON] to use the digipeater of the RELAY type (Fill-in type) with the New-N PARADIGM.
- When set to [ON], 1 packet path in addition to WIDE 1-1 can be used, as per the TOTAL HOPS setting.

- 3 Select the relay step number for the TOTAL HOPS setting.

```

12:00
PACKET PATH 612
TYPE : *New-N PARADIGM
WIDE1-1 : ON
TOTAL HOPS : 2
PATH IS VIA: WIDE1-1,WIDE2-1
ESC BACK USE
  
```

- You can confirm the setting contents in PATH IS VIA.

[RELAY PARADIGM]:

This is one of the digipeat types used in Europe.

- 1 Set the TYPE to [RELAY PARADIGM], then press [USE].

```

12:00
PACKET PATH 612
TYPE : *RELAY PARADIGM
RELAY : ON
TOTAL HOPS : 2
PATH IS VIA: RELAY,TRACE2-1
ESC BACK USE
  
```

- 2 Set RELAY to [OFF] or [ON].

```

12:00
PACKET PATH 612
TYPE : *RELAY PARADIGM
RELAY : ON
TOTAL HOPS : 2
PATH IS VIA: RELAY,TRACE2-1
ESC BACK USE
  
```

- Set RELAY to [ON] to use the digipeater of the RELAY type (Fill-in type) with the RELAY PARADIGM.
- When set to [ON], 1 packet path in addition to RELAY can be used, as per the TOTAL HOPS setting.

- 3 Select the relay step number for the TOTAL HOPS setting.

```

12:00
PACKET PATH 612
TYPE : *RELAY PARADIGM
RELAY : ON
TOTAL HOPS : 2
PATH IS VIA: RELAY,TRACE2-1
ESC BACK USE
  
```

- You can confirm the setting contents in PATH IS VIA.

[STATE/SECTION/REGION]:

Use this method when the packet is being relayed within only a limited area.

Packet paths are specified using ABBR (abbreviations). (In America, for example, CA represents California, AZ represents Arizona, etc.)

- 1 Set the TYPE to [STATE/SECTION/REGION], then press [USE].

```

12:00
PACKET PATH 612
TYPE : *STATE/SECTION/REGION
ABBR :
TOTAL HOPS : 2
PATH IS VIA: USE
ESC BACK USE
  
```

- 2 Using the ABBR setting, enter an abbreviation of up to 5 characters.

```

12:00
PACKET PATH 612
TYPE : *STATE/SECTION/REGION
ABBR : CA
TOTAL HOPS : 2
PATH IS VIA:
ESC BACK ← → INS CLR
  
```

- 3 Select the relay step number for the TOTAL HOPS setting.

```

12:00
PACKET PATH 612
TYPE : *STATE/SECTION/REGION
ABBR : CA
TOTAL HOPS : 2
PATH IS VIA: CA2-2
ESC BACK USE
  
```

- You can confirm the setting contents in PATH IS VIA.

[OTHERS]:

Use this method when the relay path is specified to an individual.

When a character string is not entered, the packet data is not relayed.

- 1 Set the TYPE to [OTHERS], then press [USE].

```

12:00
PACKET PATH 612
TYPE : *OTHERS
PATH :
ESC BACK USE
  
```

- 2 Enter a path.

```

12:00
PACKET PATH 612
TYPE : *OTHERS
PATH : W5DJY-1
ESC BACK ← → INS CLR
  
```

- A Packet path is the digipeat route of the packet data sent from My station.

For example, if you want your packet to take the [W5DJY-1] > [W4DJY-1] route, enter [W5DJY-1, W4DJY-1], separating each digipeater callsign with a comma.

NETWORK

Enter Menu mode and access Menu 613.

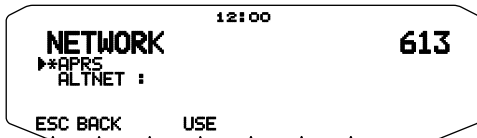

Set APRS data communications UNPROTOCOL. UNPROTOCOL is the method in which packet data is transmitted without other stations or making a connection. Select either [APRS(APK102)] or [ALTNET].

[APRS]: (Use this setting for normal use: default setting)

When transmitting messages and meteorological data using the TM-D710, "APK102" is added to the packet, following your station callsign.

There are no restrictions on received packets.

[ALTNET]: When it is necessary to add restrictions to received packets, you can set it for special use.

Select ALTNET and press **[USE]**, then enter your desired character string.

When transmitting messages and meteorological data using the TM-D710, the character string you entered is added to the packet, following your station callsign.

- When using ALTNET, enter ALTNET.

VOICE ALERT

Enter Menu mode and access Menu 614.

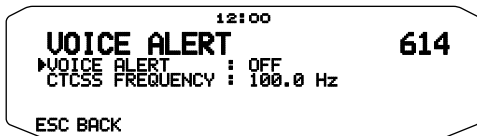

This function will notify another station as to whether or not they are within communications range by emitting beacon tones.

When a Mobile Station is mobile with the Voice Alert function turned ON, other stations also with Voice Alert turned ON will hear the beacon sound of the Mobile Station if they have matching tone (CTCSS) frequencies and are within range, thus informing the stations that communications is possible.

You can set Voice Alert to [OFF], [ON] or [RX ONLY]. When using this function, you can also change the tone frequency, press **[F]**, **[T.SEL]**. (The default is 100Hz.)

[OFF]: Voice Alert is disabled.

[ON]: A tone frequency is added to the transmitted packet. "VA" appears above the displayed frequency.

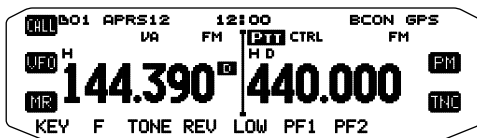

[RX ONLY]: A tone frequency is not added to the transmitted packet. "VAR" appears above the displayed frequency.

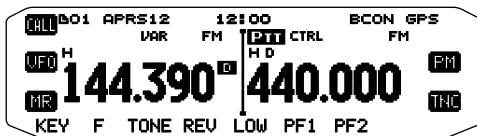

Note:

- ◆ When the built-in data band is set to cross band, the Voice Alert function does not operate.
- ◆ Voice alert takes precedence even when TONE, CTCSS and DCS are set.
- ◆ When Voice alert is ON, you cannot perform TONE or CTCSS frequency selection and DCS code selection.
- ◆ When the packet speed is 9600 bps, the TONE will disrupt the demodulation of the packet. Set the packet speed to 1200 bps when using Voice Alert.

WEATHER STATION DATA OUTPUT

Enter Menu mode and access Menu 615.

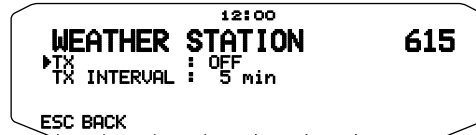

■ Transmit <TX>

This setting determines whether or not to transmit the meteorological data obtained from the Weather Station, with the APRS data communication.

■ Transmit Interval Time <TX INTERVAL>

Set the interval at which the meteorological data is transmitted with the APRS data communication.

The interval can be set to 5, 10, or 30 minutes.

- The following meteorological data is transmitted:
 - Rainfall
 - Air temperature
 - Wind direction
 - Wind velocity
 - Atmospheric pressure
 - Humidity
- This data is transmitted with the APRS standard format (latitude/longitude and time information).
- You can verify the meteorological data being output by viewing MY WEATHER STATION. (Press **[F]**, **[WXi]**)

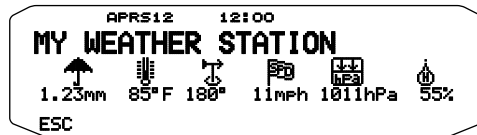

SETTING AS A DIGIPEATER

■ DIGIPEAT

Enter Menu mode and access Menu 616.



When using the TM-D710 as a digipeater, set whether or not you digipeat a packet which includes your callsign in the packet path.

In the received packet path, if you have set your callsign in MY CALLSIGN (Menu No. 600), the digipeat completion flag (*) is added to your callsign and will then process the relay. (For example, "JA1YKX-1" > "JA1YKX-1*").

■ UICHECK

Enter Menu mode and access Menu 617.

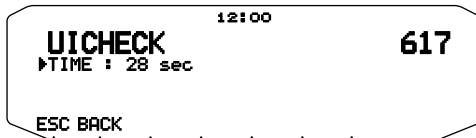

This function will not relay a one-time received UI frame within the set UICHECK time. This is effective for each of UIDIGI, UIFLOOD, and UITRACE.

UI frame (Unnumbered Information frame)

Data can be transferred and the APRS beacon, etc., can be used without making a connection. UIDIGI, UIFLOOD, and UITRACE are all specialized UI frame relay processing modes.

■ UIDIGI

Enter Menu mode and access Menu 618.

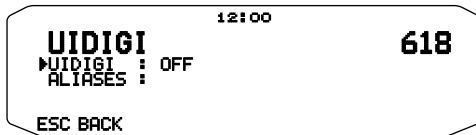

When using the TM-D710 as a digipeater, set whether or not UI digipeat is run.

When receiving a UI frame that matches your entered character string alias (RELAY, WIDE 1-1, etc.) of the beginning part of the packet path that has not yet been digipeated, the digipeat completion flag (*) is added to your callsign (the callsign you set up in MY CALLSIGN) and the relay will begin processing. (For example "WIDE 1-1" > "JA1YKX-1*", etc.)

- 1 Rotate the **Tuning** control to switch the function ON, then press the **Tuning** control.
- 2 Rotate the **Tuning** control to select "ALIASES", then press the **Tuning** control.
 - The display for entering a path appears; the first digit blinks.

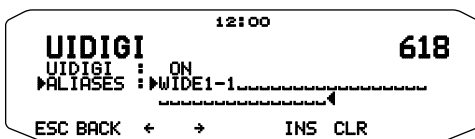

- You can enter 0 to 9, A to Z, , (comma), and -.

■ UIFLOOD

When using the TM-D710 as a digipeater, set whether or not UIFLOOD digipeat runs.

When the received UI Frame character string matches the entered alias (for example, CA), the number of hops (for example, 2-2) is processed and decreased by 1 (for example, CA2-2 becomes CA2-1).

Enter Menu mode and access Menu 619.

- 1 Set UIFLOOD to [ON] or [OFF].

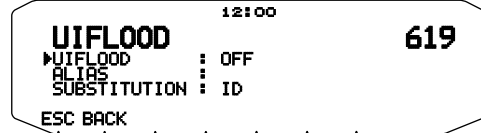

- 2 Press the **Tuning** control.
 - You enter Alias Setting mode.
- 3 Enter the UIFLOOD alias.
 - When running UIFLOOD digipeat, set the character string of the alias that is used.

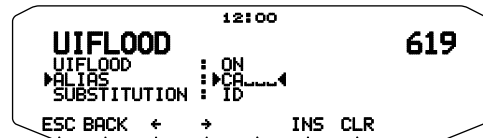

- 4 Press the **Tuning** control.
 - You enter UIFLOOD SUBSTITUTION Setting mode.
- 5 Set one of [ID], [NOID], or [FIRST].

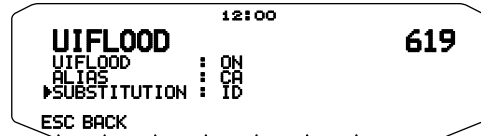

[ID]: Your station callsign is embedded. When there is already a callsign in the relayed UI frame, your station callsign will replace the existing callsign.

[NOID]: The callsign is not embedded or replaced.

[FIRST]: When there is no callsign in the relayed UI frame, your station callsign is embedded. When there is already a callsign in the relayed UI frame, the callsign is not embedded or replaced.

■ UITRACE

When using the TM-D710 as a digipeater, set whether or not UITRACE digipeat runs.

When the received UI Frame character string matches the entered alias (for example, WIDE), the number of hops (for example, 2-2) is processed and decreased by 1 (for example, WIDE2-2 becomes WIDE2-1), and your station callsign is added to the UI Frame.

Enter Menu mode and access Menu 620.

- 1 Set UITRACE to [ON] or [OFF].

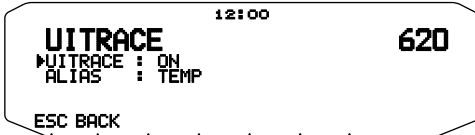

- 2 Press the **Tuning** control.
 - You enter Alias Setting mode.
- 3 Enter the UITRACE alias.
 - When running UITRACE digipeat, set the character string of the alias that is used.

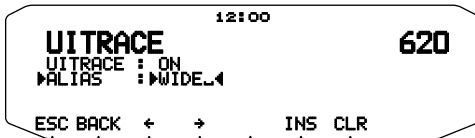

STORING USER PHRASES

Enter Menu mode and access Menu 621.



This function (clipboard image) allows you to paste phrases into the APRS message compilation mode. You can create up to 4 phrases each of which can consist of up to 32 characters.

- The user phrase function can only be used in the message compilation mode.
- Before a message is copied, the number of letters cannot be guaranteed. Only the number of letters available will be copied, the remainder will be truncated.
- To copy a message, enter message compilation mode, press [F] to enter function mode, then press [PASTE1], [PASTE2], [PASTE3], or [PASTE4] to copy the message that has been set up for each key.
- If the user messages [PASTE1], [PASTE2], [PASTE3], and [PASTE4], are not set up, they cannot be used.

STORING AUTO MESSAGE REPLY

Enter Menu mode and access Menu 622.



■ Auto Answer Reply <REPLY>

While you are driving, for example, you cannot immediately answer to received messages. On this transceiver, you can program the message to be automatically returned when a message is received.

- 1 Rotate the **Tuning** control to select "ON", then press the **Tuning** control.
- 2 Rotate the **Tuning** control to select "TEXT", then press the **Tuning** control.
 - The display for entering a message appears; the first digit blinks.



- You can enter alphanumeric characters plus special ASCII characters.

■ Reply To Callsign <REPLY TO>

When there is a message you would like to reply to for the specific callsign, preset that callsign for automatic responses.



PROGRAMMING A MESSAGE GROUP CODE

Enter Menu mode and access Menu 623.



Use a message group code to exchange messages only among your group members. With one or more message group codes programmed, you will receive messages that include the same group code(s), besides messages addressed to you. If you program one or more bulletin group codes, you will not receive bulletins addressed to other specific groups. You can program any desired code using alphanumeric characters; up to 9 characters for messages, and up to 4 characters for bulletins. You can also program up to 6 codes at the same time; each code must be separated by a comma (,). If you program 3 message group codes, for example, you will receive all messages that include one of the 3 codes. If you program 3 bulletin group codes, you will reject bulletins addressed to specific groups which do not use any of the 3 codes.



- You can enter 0 to 9, A to Z, , (comma), and -. For messages, "*" is also selectable.
- The keypad on the microphone also is available to enter alphanumeric characters.
- In order to include a message group code in your outgoing packet, enter a group code in place of a callsign. To include a bulletin group code, enter it following BLN#; for example, "BLN#ABC" where ABC is a group code. Use up to 9 characters for a message group code or up to 4 characters for a bulletin group code.

Note: Unlike a message, a bulletin including a group code will be received by stations who do not program any bulletin group code.

SETTING SOUND

Enter Menu mode and access Menu 624.

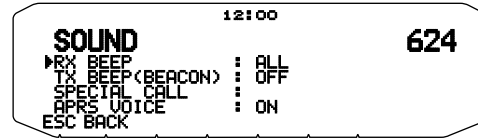

■ RX Beep Type <RX BEEP>

This transceiver beeps each time it receives any type of APRS packets.

Selection	Operation
OFF	The APRS beep tone does not sound.
MESSAGE ONLY	Beep sounds only when a message is received at your station address.
MINE	Beep sounds when a message is received at your station address and your transmitted data is received by a digipeater.
ALL NEW	Beep sounds when a message is received at your station address and new packet data is received.
ALL	Beep sounds when a message is received at your station address and duplicate data or invalid data is received.

■ TX Beep <TX BEEP (BEACON)>

When a beacon containing your station position information (My position information) is transmitted in a manner other than manually, you can select whether or not it emits a beep sound.

[OFF]: A beep does not sound.

[ON]: A beep sounds when a beacon is transmitted using the PTT switch or when it is automatically transmitted.

Note: Depending on the congestion level of the transmission channel, the transmission beep sound may be delayed when using the internal TNC DCD sense function.

■ Special Call Sound <SPECIAL CALL>

This function emits a special call sound when data is received at My station address. Set the callsign of the stations from which you want to receive special call notifications.

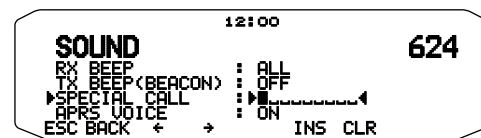

■ APRS Voice Announce <APRS VOICE>

When using an optional VGS-1 unit, you may select ON. Each time you receive a message addressed to you, the transceiver announces the callsign of the sender. If the initial character of the message is %, the transceiver announces the subsequent characters one by one.

SETTING INTERRUPT DISPLAY

Enter Menu mode and access Menu 625.



■ Display Area <DISPLAY AREA>

Selects the Display area.

[ENTIRE ALWAYS]: The received new data, duplicate data, and My station data information appears on the full display, other data information appears only at the top of the display.

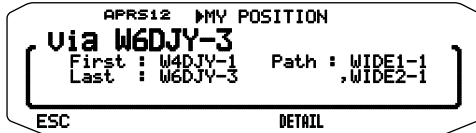

[ENTIRE]: The received new data information appears on the full display, other data information appears only at the top of the display.

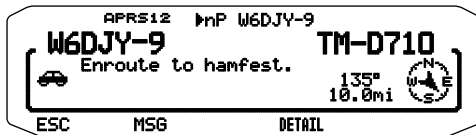

[HALF]: The received new data information appears on the left half of the display only, other data information appears only at the top of the display.

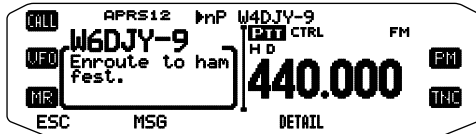

[OFF]: The received new data information appears only at the top of the display.

Note: When an emergency message or a message designated for your station is received, the received data information appears on the full display, even if the display method is set to [HALF] or [OFF]. When a status message is received, it is displayed on half of the display.

■ Automatic Brightness <AUTO BRIGHTNESS>

When ON is selected and My station address message is received, the backlight turns on (2 step).

■ Change Color <CHANGE COLOR>

When ON is selected and My station address message is received, the backlight color changes.

■ Interrupt Time <INTERRUPT TIME>

Set the duration to display an indication for when new data is received. If you select "Infinite", the indication cannot be canceled.

The Interrupt time can be set to 3, 5, 10 seconds or "INFINITE".

SELECTING A DISPLAY UNIT (1)

Enter Menu mode and access Menu 626.

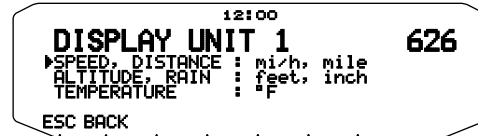

■ Speed, Distance <SPEED, DISTANCE>

Select to [mi/h, mile], [km/h, km], or [knots, nm] .

■ Altitude, Rainfall <ALTITUDE, RAIN>

Select to [feet, inch] or [m, mm].

■ Temperature <TEMPERATURE>

Select to [°F] or [°C].

SELECTING A DISPLAY UNIT (2)

Enter Menu mode and access Menu 627.

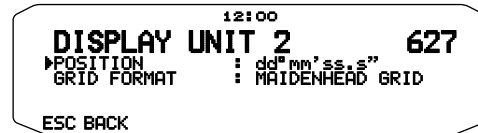

■ Latitude longitude <POSITION>

Select to [dd°mm. mm'], or [dd°mm' ss. s"] .

■ Grid Format <GRID FORMAT>

Select to [MAIDENHEAD GRID], [SAR GRID (CONV)], or [SAR GRID (CELL)] .

SELECTING A NAVITRA GROUP

Enter Menu mode and access Menu 628.



■ Group Mode <GROUP MODE>

Select to Group mode ON or OFF.

■ Enter Group Code <GROUP CODE>

You can enter 0 to 9, A to Z.

STORING NAVITRA MESSAGE

Enter Menu mode and access Menu 629.



You can create up to 5 phrases each of which can consist of up to 20 characters.

SETTING SmartBeaconing™

Enter Menu mode and access Menu 630 and 631.

```

12:00
SMARTBEACONING 1      630
LOW SPEED : 5
HIGH SPEED : 70
SLOW RATE : 30 min
FAST RATE : 120 sec
ESC BACK
    
```

```

12:00
SMARTBEACONING 2      631
TURN ANGLE : 28 deg
TURN SLOPE : 26 (10deg/speed)
TURN TIME : 30 sec
ESC BACK
    
```

Set to use [SmartBeaconing] (Menu No.611) with APRS data transmission.

This function optimizes beacon transmission based on driving direction and speed. Use this function when you want to track your transmissions, especially for optimizing crossover beacon transmission intervals.

■ Low speed <LOW SPEED>

Low speed setting (2 ~ 30 <mi/h, km/h or knots>). When the speed is lower than this, beacons are transmitted at the time interval specified under SLOW RATE.

Note: To select the speed setting of the units, access Menu 626 (DISPLAY UNIT 1 - SPEED, DISTANCE).

■ High speed <HIGH SPEED>

High speed setting (2 ~90 <mi/h, km/h or knots>). When the speed is faster than this, beacons are transmitted at the time interval specified under FAST RATE.)

Note: To select the speed setting of the units, access Menu 626 (DISPLAY UNIT 1 - SPEED, DISTANCE).

■ Slow rate <SLOW RATE>

Low speed transmission interval time (1 ~ 100 minutes).

■ Fast rate <FAST RATE>

High speed transmission interval time (10 ~ 180 seconds).

■ Turn angle <TURN ANGLE>

Driving direction change, minimum value setting (5 ~ 90 degrees).

■ Turn slope <TURN SLOPE>

Driving direction change, additional value setting (1 ~ 255 (10degrees/speed)).

■ Turn time <TURN TIME>

Minimum time delay between each beacon transmission by change of direction. (5 ~ 180 seconds).

Note:

- ◆ When Menu No. 602 is set to a value other than [GPS], it operates at the SLOW RATE.
- ◆ Adjust the Setting values to match the actual driving status.

SmartBeaconing Operation:

Speed	Transmission Interval	Corner Pegging
Above the HIGH SPEED	FAST RATE	Operates normally
Under HIGH SPEED Over LOW SPEED (Only when the set HIGH SPEED ≥ LOW SPEED)	The interval is calculated using the following formula: (Transmission Interval = FAST RATE x HI SPEED ÷ Speed)	Operates normally
Below the LOW SPEED	SLOW RATE	Will not operate

Transmission Interval Example:

(with LOW SPEED = 5, HIGH SPEED = 70, SLOW RATE = 30 min, FAST RATE = 120 sec)

Speed	Interval
80	120 seconds (2 minutes)
70	120 seconds (2 minutes)
50	168 seconds (2 minutes 48 seconds)
30	280 seconds (4 minutes 40 seconds)
20	420 seconds (7 minutes)
10	840 seconds (14 minutes)
5	1680 seconds (28 minutes)
0	1800 seconds (30 minutes)

Corner Pegging Operation Example:

(with TURN ANGLE = 30°, TURN SLOPE = 24)

Speed	TURN SLOPE	TURN SLOPE ÷ Speed (1)	TURN ANGLE (2)	Turn Threshold (3)=(1)+(2)
60	24 (x10)	4°	30°	34°
50	24 (x10)	6°	30°	36°
30	24 (x10)	8°	30°	38°
20	24 (x10)	12°	30°	42°
10	24 (x10)	24°	30°	54°
5	24 (x10)	40°	30°	78°

- When the value of [Turn Threshold] exceeds 120°, it is calculated as 120°.

< SmartBeaconing™ from HamHUD Nichetronix >

PACKET MONITOR DISPLAY

This transceiver presents Terminal Window mode to display raw data of received APRS packets. It displays up to 155 characters per page and holds up to 10 pages.

1 Press [KEY], [P.MON].

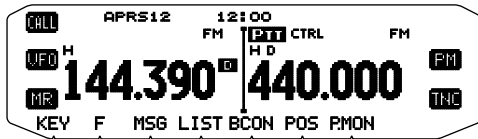

- To enter Terminal Window mode.

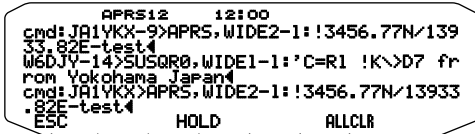

2 To access old pages, press [HOLD].

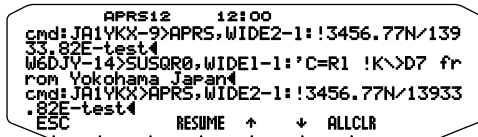

- Rotate the **Tuning** control or press [**↑**] or [**↓**] to change the page.
- Press [**RESUME**] to quit the Hold function.
- While using the Hold function, newly received packets will not be stored in buffer.
- When press [**ALLCLR**], packet monitor display is cleared.

Note:

- The terminal window is not available for sending a command to the TNC.
- The terminal window is available in APRS mode (not in Packet mode).
- The data in buffer is cleared when the transceiver power is turned OFF.

DX PACKETCLUSTERS MONITOR

DX PacketClusters are networks which consist of nodes and stations who are interested in DXing and contesting. If one station finds a DX station on the air, he (or she) sends a notice to his (or her) node. Then this node passes the information to all its local stations besides another node. This transceiver can display received DX information and hold the latest information on up to 10 DX stations. Use this function to monitor the latest DX information in your local area. You cannot send DX information to a node, using the function.

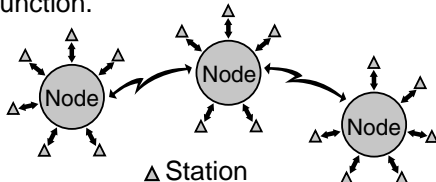

1 Access Menu 601 (INTERNAL TNC - DATA BAND) to select band A or B.

- If the common transfer rate in your local PacketCluster network is 9600 bps, access Menu 601 (INTERNAL TNC - PACKET SPEED) and select "9600 bps".

2 Tune to the frequency of the target PacketCluster node.

3 Press [TNC] to enter APRS mode.

- "APRS" should appear.

4 Press [F], [DX].

- Each time new DX cluster data is received, a callsign, frequency, and time are displayed.
- Information of up to 5 DX stations are displayed at the same time.
- When a duplicate DX cluster data is received, "dD" and a callsign are displayed.

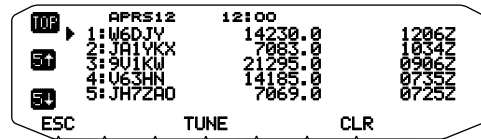

[**TOP**]: Displays the list of the fast 5 stations.

[**5↑**]: Displays the list of the previous 5 stations.

[**5↓**]: Displays the list of the next 5 stations.

[**ESC**]: Restores the frequency display..

[**TUNE**]: Outputs the PCT data.

[**CLR**]: Deletes the current DX station.

- DX station detailed display mode

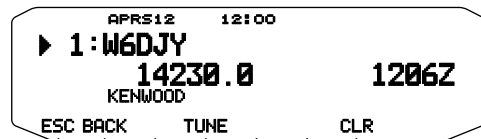

[**ESC**]: Restores the frequency display.

[**BACK**]: Returns to the DX station list

[**TUNE**]: Outputs the PCT data.

[**CLR**]: Deletes the current DX station.

■ Connecting TM-D710 with the HF Transceiver

In order to connect TM-D710 to the HF transceiver, you need to prepare three cables by yourself. For the connection between the PC/ COM connectors on the two transceivers, you may use a commercially available RS-232-C cross-wired cable.

- A D-SUB female/male conversion adapter is required.

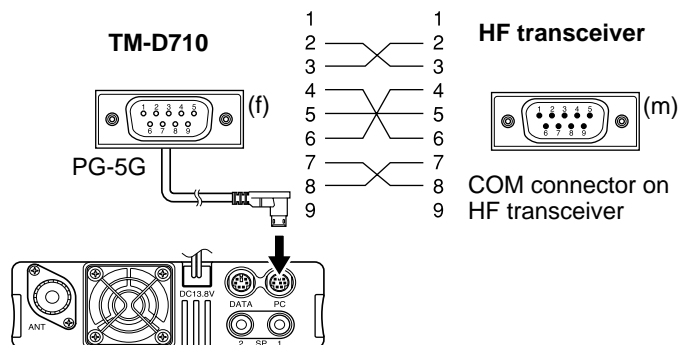

TRANSCEIVER RESET

There are 4 types of transceiver reset available:

VFO Reset

Use to initialize the VFO and accompanying settings.

PARTIAL (Partial) Reset

Use to initialize all settings other than the Memory channels, the DTMF memory, and the PM channels.

PM Reset

Use to reset only the Programmable Memory channels to their default values.

FULL Reset

Use to initialize all transceiver settings that you have customized. (Date and time are not reset.)

There are 2 ways to perform a reset on the transceiver: by key operation and by accessing Menu mode.

KEY OPERATION

- 1 Turn the transceiver power OFF.
- 2 Press **[F] + Power ON**.
- 3 Rotate the **Tuning** control and select your desired reset type: VFO RESET, PARTIAL RESET, PM RESET, or FULL RESET.

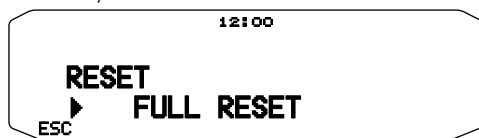

- 4 Press the **Tuning** control to set the reset type.
 - A confirmation message appears on the display.



- Press **[BACK]** to return to the previous display or **[ESC]** to cancel the reset.
- 5 Press the **Tuning** control again to perform the reset.

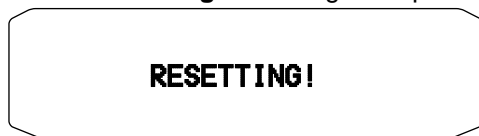

Note: When in Remote Control or Repeater mode, you cannot reset the transceiver using the Key Operation method.

MENU MODE

- 1 Enter Menu mode and access Menu 999.



- 2 Set the reset type to VFO RESET, PARTIAL RESET, PM RESET, or FULL RESET.

- 3 Press the **Tuning** control to set the reset type.

- A confirmation message appears on the display.

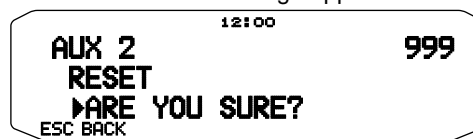

- Press **[BACK]** to return to the previous display or **[ESC]** to cancel the reset.

- 4 Press the **Tuning** control again to perform the reset.

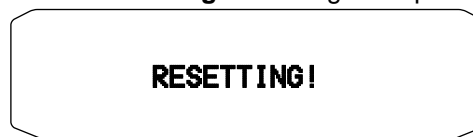

Note: When the Channel Display function or Key Lock function is ON, the transceiver reset cannot be performed.

VGS-1 (OPTIONAL) OPERATION

When using the optional VGS-1 voice guide & storage unit, you gain access to the voice recorder and voice announcement functions. <The VGS-1 is sold depending upon area.>

VOICE ANNOUNCEMENTS

When changing modes, frequencies, settings, etc., an audio voice will announce the new information.

- Voice announcements are output from the PTT band side.

1 Enter Menu mode and access Menu 003.

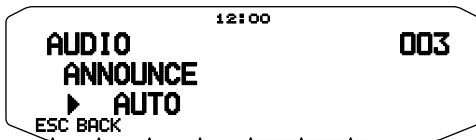

2 Set the announcement function to MANUAL, AUTO, or OFF.

- Refer to the tables below for announcements based on settings.

MANUAL: A microphone PF key must be programmed as [VOICE] to use MANUAL voice announcement.	
Operation	Announcement
While in VFO mode	Press [VOICE]: Operating band frequency
While in MR mode	Press [VOICE]: "Channel" + Channel number + operating band frequency
While in Call mode	Press [VOICE]: "Call channel" + operating band frequency
While in Menu mode	Press [VOICE]: Menu number or setting value (some selections have no voice announcement)
Tone frequency setup	Press [VOICE]: "Tone frequency" + frequency value
CTCSS frequency setup	Press [VOICE]: "CTCSS frequency" + frequency value
DCS code setup	Press [VOICE]: "DCS" + code value

AUTO:

Announcements are made automatically when changing a mode/frequency/setting.

Operation	Announcement
Press [VFO]	"VFO"
Press [MR]	"MR"
Press [CALL]	"Call"
Press [MENU]	"Menu" + menu number
Press [F]	"Function"
Press [PM]	"PM"
Press [ENT]	"Enter"
Change the operating band/ turn the power ON	"A"/"B" + "Channel" (for MR only) + "Call"/channel number + "Channel" (for CALL only) + operating band frequency + output power level
Change the frequency band	New receive frequency
Setting up the PM	Channel number/"Off"
Frequency direct entry	Entered key number
Memory Direct Entry mode	Channel number
Press [F], rotate Tuning control	On stored channel "Memory in" + channel number + frequency
Press [F], [M.IN] in VFO mode	On blank channel "Memory in" + channel number + "Blank"
Press [A/B] in VFO mode	"A"/"B" + frequency + output power level
Press [F] and then the Tuning control in VFO mode	"Menu" + "Mode" + The main Menu number corresponds to the first digit. (For example, "5" is Menu No. 5xx.)
Select Menu number in category	"Menu" + menu number
Select setting value in Menu mode	Setting value
Clearing a memory channel	"Memory"+ channel number + "Clear"
Perform a Full Reset	"Full reset?"
Perform a Partial Reset	"Partial reset?"
Perform a VFO Reset	"VFO reset?"
Perform a PM Reset	"PM reset?"

AUTO:	
Announcements are made automatically when changing a mode/frequency/setting.	
Operation	Announcement
Press [LOCK] (to turn the Lock function ON)	"Lock on"
Press [LOCK] (to turn the Lock function OFF)	"Lock off"
Tone frequency setup	"Tone frequency" + frequency value
CTCSS frequency setup	"CTCSS frequency" + frequency value
DCS code setup	"DCS" + code value
MHz step frequency setup	"MHz Step" + frequency value
10 MHz setup	"10" + "MHz setup" + frequency value
Output power setup	"TX Power" + power level
Receiving APRS message	Call sign + "Message" + APRS message

■ Voice Announcement Language

- 1 Enter Menu mode and access Menu 004.



- 2 Set the language to ENGLISH or JAPANESE.

■ Voice Announcement Volume

- 1 Enter Menu mode and access Menu 005.

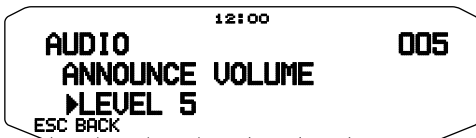

- 2 Set the announcement volume level from 1 to 7.
 - To turn the volume OFF, turn the announcement function OFF.

■ Voice Announcement Speed

- 1 Enter Menu mode and access Menu 006.

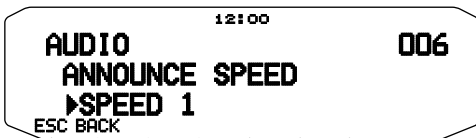

- 2 Set the announcement speed level from 0 to 4.
 - The speed settings are as follows:
 - 0: 0.85 times normal speed
 - 1: Normal speed
 - 2: 1.15 times normal speed
 - 3: 1.30 times normal speed
 - 4: 1.45 times normal speed

VOICE RECORDER

The voice recorder provides you with 3 VGS channels for recording voice memos, along with a single VGS channel for continuous recording. You can also prepare automated message responses to received calls.

Each recording can last for up to 30 seconds.

■ Voice Memos

To record a voice memo, for later playback:

- 1 Press the PF key programmed as [VGS].

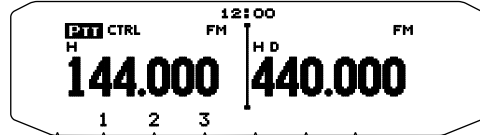

- 2 Press and hold the key for the VGS channel number you want to store the memo in: [1], [2], or [3].

- A beep will sound and the transceiver will enter Recording mode.

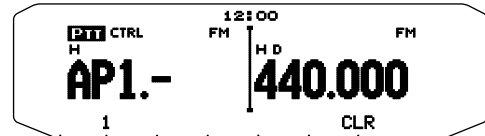

- 3 Press and hold the VGS channel number key again (the same key you pressed in the previous step), then speak into the microphone to record your memo.

- Recording begins as soon as you press the VGS channel number key, and a timer appears on the display.
- Pressing the microphone PTT switch at this time will transmit your message as well as record it. Do not press the microphone PTT switch if you do not want to transmit your message.

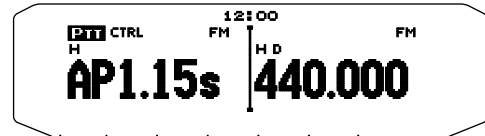

- 4 Release the VGS channel number key to end the recording at any time and store it into the selected VGS channel.

- If the memory becomes full, recording will stop automatically and store the voice memo to memory.
- "WRITING" appears on the display while the recording is being stored to memory.

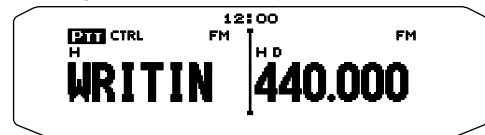

- To exit, press [VGS] again.

■ Continuous Recording

Received signals on the control band are continuously recorded, with the memory retaining the last 30 seconds of recorded signals.

- 1 Enter Menu mode and access Menu 009.



- 2 Set the Continuous Recording to ON (or OFF).
 - When selecting "ON", Continuous Recording turns ON. When the control band squelch opens, the  icon appears on the display and Received signals are recorded.
 - Received signals are saved in the SRAM memory.

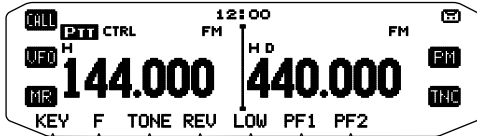

- 3 Press the PF key programmed as [VGS].

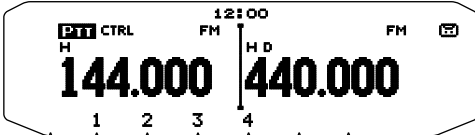

- 4 Press [4] (1s).
 - Up to 30 seconds of received signal recordings from the SRAM memory are written to channel 4.

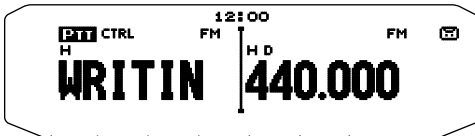

Note: The  icon does not appear during playback, in Repeater mode, or in Remote Control mode.

■ Playback

- 1 Press the PF key programmed as [VGS].

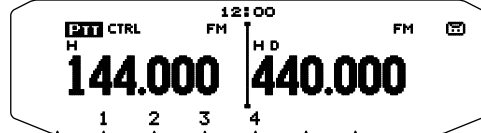

- When preparing to transmit, press the [PTT] switch before pressing the channel number (1 - 3) key.
- 2 Press the key for the VGS channel number you want to playback: [1], [2], [3], or [4] (when the Continuous Recording is ON).
 - The recording saved in the channel you selected is played back.

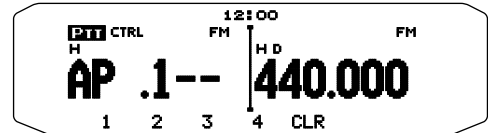

- To end playback at any time, press [CLR].
- Playback signals are output from the PTT band side. Use the [BAND SEL (VOL)] of the PTT band to adjust the speaker volume.
- To exit, press [VGS] again.
- During playback, you can switch to any of recordings 1, 2, 3, or 4 by pressing the appropriate key.

■ Playback Repeat

You can set messages to be repeatedly played back.

- 1 Enter Menu mode and access Menu 007.

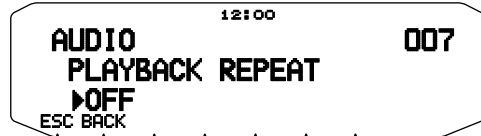

- 2 Set the the Playback Repeat function to ON or OFF.

■ Playback Repeat Interval

If the Playback Repeat function is activated, you can set a time interval for how often the memo/message is played back.

- 1 Enter Menu mode and access Menu 008.



- 2 Set the interval from 0 to 60 seconds.

CROSS-BAND/ LOCKED-BAND OPERATION (K TYPE MODELS ONLY)

This transceiver is capable of receiving signals on one band and retransmitting signals on the other band. This function repeats signals originating from one band, using the other band. For example, a signal received on band A (VHF) is retransmitted on band B (UHF). Similarly, a signal received on band B (UHF) is retransmitted on band A (VHF).

Locked-band Repeater: The transceiver uses the same band to receive or transmit a signal. You can set either the A band (A-TX) or B band (B-TX) as the transmit band.

Cross-band Repeater: If receiving a signal on the TX band, the transceiver switches the current RX only band to the TX band. This is useful when joining in a group talk. Participants in a group talk need to set a receive and transmit frequency on different bands so as not to miss any conversation within the group.

REPEATER OPERATION MODE

- 1 Enter Menu mode and access Menu 403.



- 2 Set the Repeater operation mode to CROSS BAND, LOCKED TX:A-BAND, or LOCKED TX:B-BAND.
- 3 Turn the transceiver power OFF.
- 4 Press **[TONE] + Power ON**.
 - The Repeater mode is ON and the **PTT** and **LOCK** icons blink on the display.
 - You are unable to perform any transceiver functions while in Repeater mode.
 - To return to normal operation, turn the transceiver power OFF, then press **[TONE] + Power ON**.

Note:

- ◆ You cannot activate the Repeater function while in single band operating mode or Weather Channel mode.
- ◆ Activating the Repeater function switches OFF the Automatic Simplex Checker (ASC).
- ◆ The Time-Out Timer is locked at 3 minutes.
- ◆ Resetting the transceiver will not cancel the Repeater mode.

REPEATER TX HOLD

If necessary, you can set the transceiver to remain in the transmit mode for 500 ms after a signal drops.

- 1 Enter Menu mode and access Menu 404.

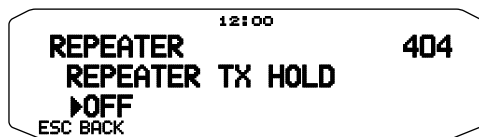

- 2 Set the Repeater Hold function to ON or OFF.

REPEATER ID TX

If necessary, you can set the transceiver to transmit your call sign every 10 minutes.

- 1 Enter Menu mode and access Menu 406.

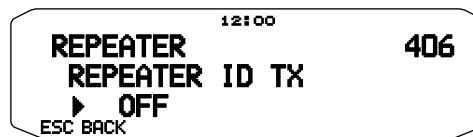

- 2 Set the ID Transmit function to OFF, MORSE, or VOICE.
 - To use VOICE transmission, you must have the VGS-1 option installed. When using the VGS-1 option, the ID Transmit function will use VGS channel 3 as the call sign.
 - When selecting MORSE, the call sign stored in Menu 405 (see below) will be transmitted at 20 wpm (words per minute).

Entering your Repeater ID

- 1 Enter Menu mode and access Menu 405.



- 2 Enter your call sign.

WIRELESS OPERATION (K TYPE MODELS ONLY)

If you also have a compatible **Kenwood** handy transceiver, you may use it as a remote control for this mobile transceiver. You will control one band on the mobile while sending DTMF tones to the other band from the handheld. This function is useful, for example, when you want to control the mobile from a location outside your vehicle.

- Note:**
- ◆ As a remote control, you can also use a handy transceiver which does not have a remote control function but a DTMF function. However, you must manually send DTMF tones for control code strings. Skip steps 1 and 3 in "PREPARATION".
 - ◆ The FCC rules permit you to send control codes only on the 440 MHz band.

PREPARATION

Let us assume band A (VHF) of the mobile transceiver will be controlled.

On the handy transceiver:

- 1 Program a 3-digit secret number.
 - For the programming method, see the instruction manual for the handheld.
- 2 Select the transmit frequency on the UHF band.
- 3 Make the handheld enter Remote Control mode.
 - For the method, see the instruction manual for the handheld. If not described, consult your dealer.

On the mobile transceiver:

- 4 Enter Menu mode and access Menu 522.

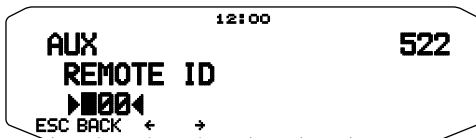

- 5 Set the ID code to the same secret number you set on the handy transceiver.
- 6 Select the receive frequency on band B (UHF).
 - Match this frequency with the transmit frequency on the handheld.
- 7 Select band A (VHF) as the TX band or Control band.
- 8 To cause the mobile to send a control acknowledgment to the handheld, enter Menu 523 and set it to ON.
 - DTMF tones which represent the secret number will be used as an acknowledgment.

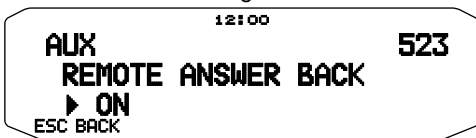

- 9 Turn the transceiver power OFF.
- 10 Press **[REV] + Power ON** to enter Remote Control mode.
 - The **CTRL** and **LOCK** icons appear on the display.
 - To exit Remote Control operation, turn the transceiver power OFF, then press **[REV] + Power ON** again.

CONTROL OPERATION

While in Remote Control mode, the DTMF keys of the handheld will function as shown in the table below. Each time you press the desired key, the handheld will automatically enter transmit mode and send the corresponding command to the mobile.

Note: If using a handheld without a remote control function, manually send "AXXX#YA#" where "XXX" is a 3-digit secret number and "Y" is a single-digit control command. If you do not add "A#" to the end, you can skip sending "AXXX#" next time; however, the mobile may be accidentally controlled by other stations.

Operation	DTMF Command
Access your mobile via the remote unit (where *** is your 3-digit secret number)	A *** #
End access of your mobile via the remote unit	A #
DCS ON	1
Tone ON	2
CTCSS ON	3
DCS OFF (all signalling OFF)	4
Tone OFF (all signalling OFF)	5
CTCSS OFF (all signalling OFF)	6
Call mode ON	7
VFO mode ON	8
Memory mode ON	9
Transmit power (press to toggle between High, Medium, and Low)	0
Frequency (in VFO mode) or Memory channel (in Memory mode) directy entry	A XXXXXXX
DCS code (when DCS is ON), Tone frequency (when Tone is ON), or CTCSS frequency (when CTCSS is ON) setup	B XXX (DCS code) BA XXX (Tone/ CTCSS frequency)
Repeater (Cross-band or Locked-band) ON	C
Repeater OFF	D
Step the frequency or Memory channel down	*
Step the frequency or Memory channel up	#

WEATHER ALERT (K TYPE MODELS ONLY)

The Weather Alert is available only in the USA and Canada. When activated, this function will check for a received NOAA 1050 Hz tone. When the tone is received, the weather alert tone will sound.

WEATHER ALERT ON/ OFF

- 1 Enter Menu mode and access Menu 110.



- 2 Set the Weather Alert to ON or OFF.
 - When activated, the **WX** icon appears on the display.
 - When a signal is being received, the **WX** icon blinks.

Weather Channel

Whether or not the Weather Alert is activated, you can still access the weather channels. The Weather Alert simply notifies you of activity on the weather channels.

- 1 Press the key programmed with the **WX** function.
- 2 Rotate the **Tuning** control to select your desired channel.

Channel No.	Frequency (MHz)	Memory Name	Location
A1	162.550	WX 1	NOAA/ Canada
A2	162.400	WX 2	NOAA/ Canada
A3	162.475	WX 3	NOAA/ Canada
A4	162.425	WX 4	NOAA
A5	162.450	WX 5	NOAA
A6	162.500	WX 6	NOAA
A7	162.525	WX 7	NOAA
A8	161.650	WX 8	Canada
A9	161.775	WX 9	Canada
A10	163.275	WX 10	—

SKY COMMAND SYSTEM II (K AND E TYPES MODELS ONLY)

The SKY COMMAND SYSTEM II allows remote control of a TS-2000, TS-2000X, TS-B2000, TS-480HX, TS-480SAT, TS-570D, TS-570S, TS-590S, or TS-870S HF transceiver.

You will use one transceiver as a control station called "Commander". The transceiver connected with the HF transceiver is called "Transporter". It will function as an interface between the Commander and the HF transceiver. This system allows you, for example, to watch for and hunt DX while washing your car, or to operate the HF transceiver while relaxing in your car, living room, or patio, instead of in your shack.

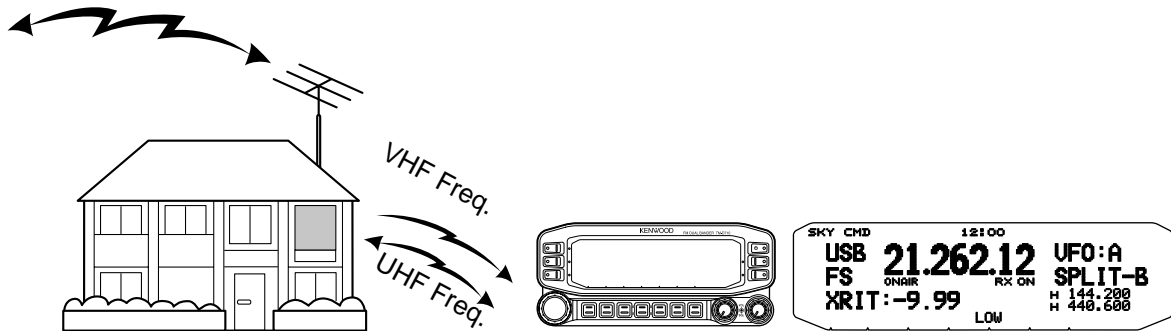

The Commander and Transporter transfer audio and commands as below:

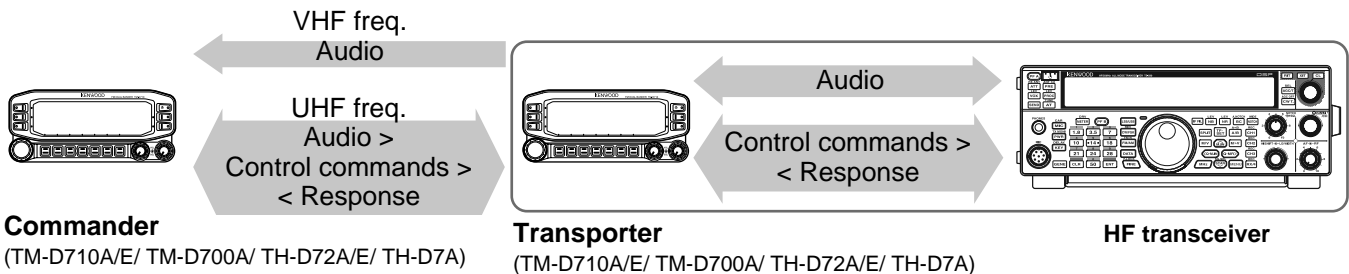

CONNECTING THE TRANSPORTER WITH THE HF TRANSCEIVER

In order to connect the transporter to the HF transceiver, you need to prepare three cables by yourself. For the connection between the PC/ COM connectors on the two transceivers, you may use a commercially available RS-232-C cross-wired cable (A D-SUB female/male conversion adapter is required.)

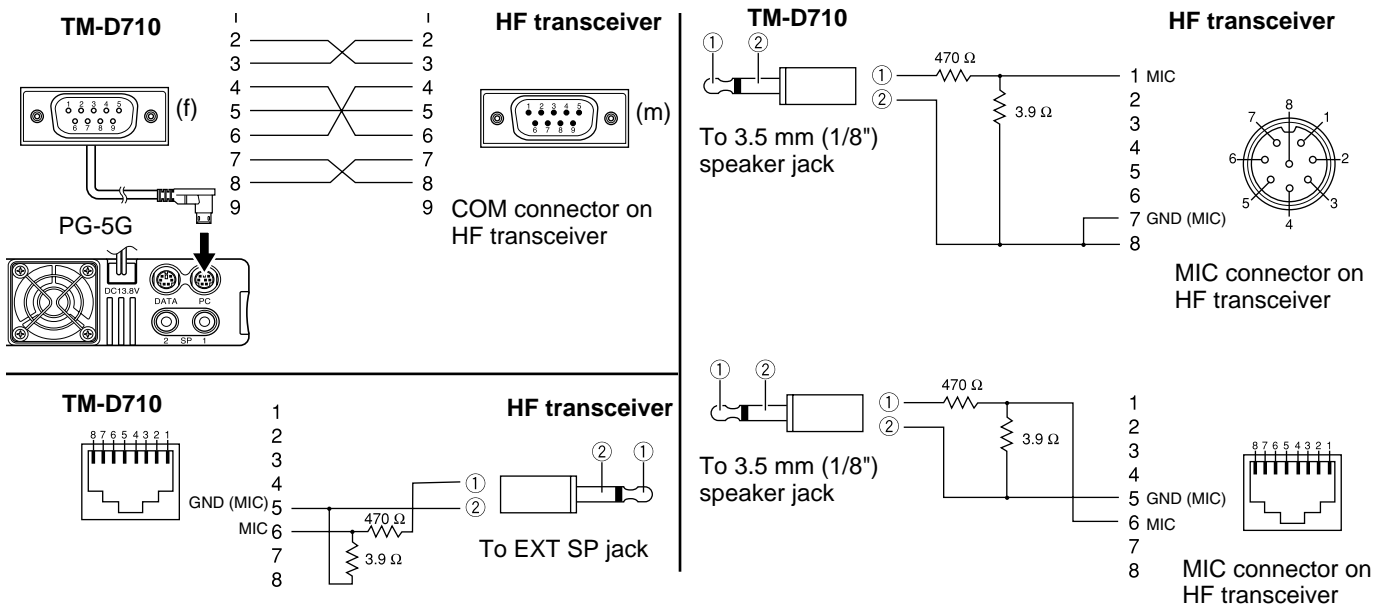

- Note:**
- ◆ Operation of SKY COMMAND SYSTEM II may not be permitted in certain countries. Check your local laws before operating.
 - ◆ Switch OFF both the Transporter and HF transceiver before making the connection.
 - ◆ The Transporter automatically transmits its call sign in Morse at regular intervals because of legal requirements; therefore, transmit side tone must be output from the HF transceiver.
 - ◆ When the Transporter is too close to the HF transceiver, unwanted feedback may cause malfunction.
 - ◆ Do not share a regulated power supply between the Transporter and the HF transceiver. Unwanted feedback may cause malfunction.

PREPARATION FLOW

The following steps should guide you to a good start of Sky Command operation. First connect the Transporter to the HF transceiver.

- 1 <On the Commander and Transporter> Select the same VHF and UHF frequencies.

Band A: VHF frequency Band B: UHF frequency
 or
 Band A: UHF frequency Band B: VHF frequency

Note: Configure the squelch to an appropriate level for both the VHF and UHF band on the Commander and Transporter. If the squelch is not set to an appropriate level, the transceivers may enter a BUSY state due to noise signals and be unable to transmit.

- 2 <On the Commander> Access Menu 700 to program a callsign (9 digits max.) for the Commander.

- You may enter your exact callsign; ex. W6DJY.



- 3 <On the Commander> Access Menu 701 to program a callsign (9 digits max.) for the Transporter.

- This callsign must be different from the one for the Commander. So you may add SSID characters; ex. W6DJY-1.



- 4 <On the Transporter> Access Menu 700 to program the same callsign as you entered in step 2.

- 5 <On the Transporter> Access Menu 701 to program the same callsign as you entered in step 3. The same callsign as you entered in step 3.

- 6 <On the Commander and Transporter> Access Menu 702 and select the tone frequency.

- Select the same tone frequency on both transceivers.

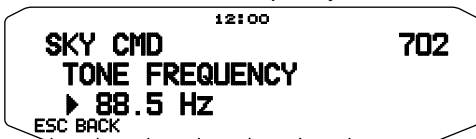

- 7 <On the Commander> Access Menu 703 and select "COMMANDER".



- "Push [0] key to start Commander!!" appears.

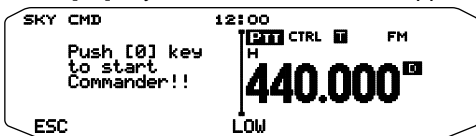

- 8 <On the Transporter> Access Menu 703 and select "TRANSPORTER".



Now the Commander and Transporter are in Sky Command mode. For operations in this mode, see "CONTROL OPERATION". First switch ON the HF transceiver and press [SYNC] on the Commander. To exit the Sky Command mode, access Menu 703 and select "OFF".

Note:

- Unless you program callsigns, you cannot select "COMMANDER" or "TRANSPORTER" using Menu 703.
- On the HF transceiver, select 9600 bps and 1 stop bit (default) using the Menu Set-up function.
- Adjust the audio level on both the Transporter and HF transceiver while listening to audio output from the Commander. An appropriate position of the AF control on the HF transceiver might be in the range, 8:30 to 9:00.
- To distinguish your various stations or nodes, you can have up to 15 Secondary Station IDentifiers (SSIDs); ex. W6DJY-1 to W6DJY-15. You always have to put a dash between your callsign and SSID number.

ATTENTION: Use only after verifying that there is no reception disruption during communications.

PROGRAMMING CALLSIGNS

The built-in TNCs of the Commander and Transporter communicate each other when you send a control command from the Commander. So you must program different callsigns (9 digits max.) on these transceivers as the IDs of the TNCs.

Use the following Menu Nos. to program callsigns:

On Commander		
700	COMMANDER CALLSIGN	Callsign for Commander
701	TRANSPORTER CALLSIGN	Callsign for Transporter
On Transporter		
700	COMMANDER CALLSIGN	Callsign for Commander
701	TRANSPORTER CALLSIGN	Callsign for Transporter

- Access Menu 700 or 701, then press the **Tuning** control.
 - The callsign entry field appears; the first digit blinks.

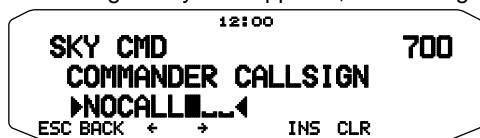

- Rotate the **Tuning** control to select a character.
 - You can enter 0 to 9, A to Z, and -.
- Press **[→]**.
 - The cursor moves to the next digit.
- Repeat steps 2 and 3 to enter up to 9 digits.
 - [BACK]**: Cancels entry of a callsign.
 - [←]**: Causes the cursor to move backward.
 - [INS]**: Inserts the currently selected character.
 - [CLR]**: Deletes the digit at which the cursor is blinking.
- Press the **Tuning** control to complete the setting.
- Press **[ESC]** to exit Menu mode.

The keypad on the Microphone also is available to enter alphanumeric characters in step 2.

PROGRAMMING A TONE FREQUENCY

On receiving a tone from the Commander, the Transporter causes the HF transceiver to enter Transmit mode. On both the Commander and Transporter, access Menu 702 and select the desired, same tone frequency.

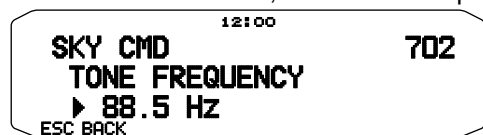

CONTROL OPERATION

When in the Sky Command mode, the Microphone keys of the Commander will function as below. First switch ON the HF transceiver and press Microphone [0] on the Commander.

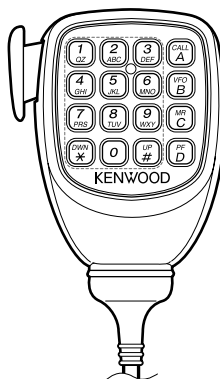

Each time you press the desired key, the Commander will automatically enter transmit mode and send the corresponding control command to the Transporter.

Key	Function
[1] (PWR)	Power ON/ OFF
[2] (RX)	HF frequency receive ON/ OFF
[3] (MODE)	Modulation mode switch
[4] (RIT)	RIT ON/ OFF
[5] (XIT)	XIT ON/ OFF
[6] (CLR)	RIT offset or XIT offset clear
[7] (SPLIT)	Split-frequency ON/ OFF
[8] (M>V)	Transfer from Memory to VFO
[9] (A/B)	In VFO mode: VFO A/ VFO B switch In Memory Recall mode: no change
[0] (SYNC)	Current settings retrieve (from HF transceiver)
[A] (MONI)	To monitor the UHF band on the Commander
[B] (M/V)	VFO/ Memory Recall mode switch
[C] (UP)	XIT/ RIT offset frequency increase
[D] (DOWN)	XIT/ RIT offset frequency decrease
[*] ¹ (FAST)	In LSB, USB, or CW mode: 10 Hz/ 1 kHz switch In FM or AM mode: 1 kHz/ 10 kHz switch
[#] ² (ENTER)	In VFO mode: frequency entry ON In Memory Recall mode: channel number entry ON
[PTT]	To transmit audio on an HF frequency

¹ "FS" appears when you select 1 kHz step (LSB/ USB/ CW) or 10 kHz step (FM/ AM).

² After pressing Mic [#], press Mic [0] to [9] to enter a frequency or memory channel number.

Note: To change the frequency or memory channel on the HF transceiver, rotate the **Tuning** control.